



PRODUCT CATALOG

SuperPro
* **BETTANIN**





Our Story

SuperPro commenced its trajectory in 2002.

Still as a business unit of the company BETTANIN, there was a great acceptance for its professional cleaning solutions, in addition to the growth of this market.

Thus, in 2009, SuperPro gained autonomy, recognition for its technology and national and international relevance becoming a company of the solid InBeta group.

Nowadays, SuperPro has the largest line of professional cleaning products in the market, growing more and more each year, in product mix, market coverage and customers served throughout the country.



INDEX

Products

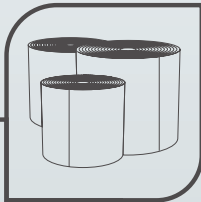

Rolls and Cloths

4

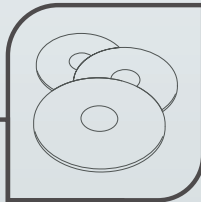

Floor Discs

16

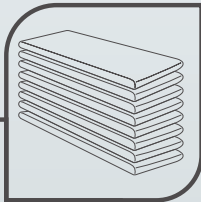

Fibers

20

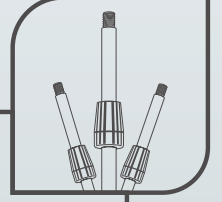

Handles

26

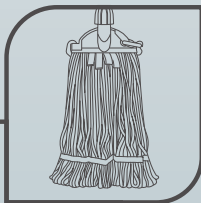

Mops and Holders

30

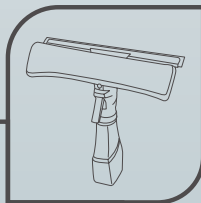

Squeegees

40

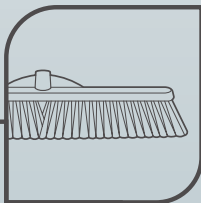

Brooms

48

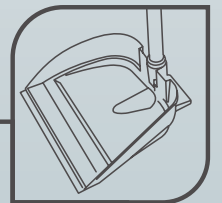

Shovels

54

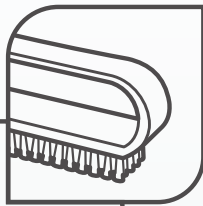

Brushes

56

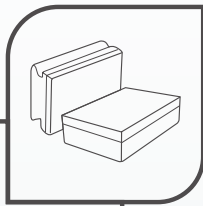

Sponges

62

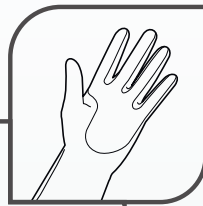

Gloves

70

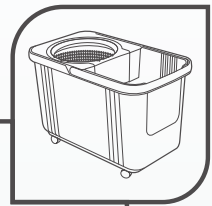

Buckets

74

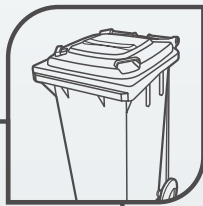

Trash cans

82

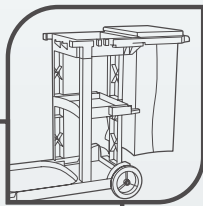

Caddies

86

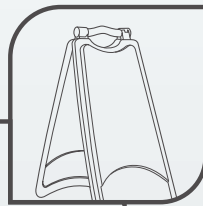

Boards and
Signs

90

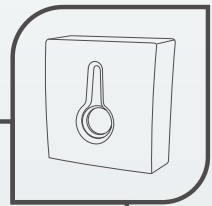

Dispensers

92

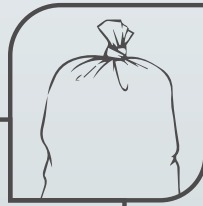

Garbage Bags

98

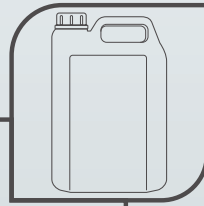

Chemical

102

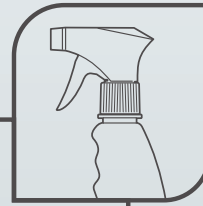

Utilities

114

SuperPro

 **BETTANIN**



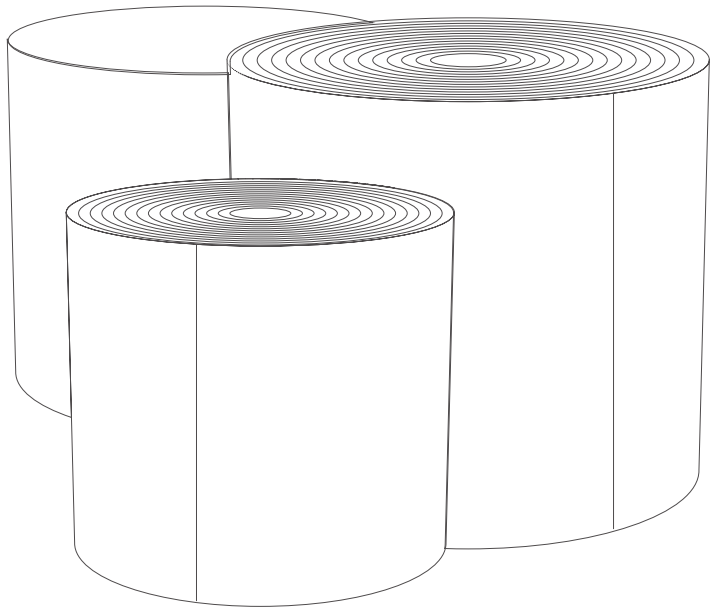

Rolls and Cloths

GLASS/INOX CLEANER DAMP CLOTH

Wet SuperPro Glass and Stainless Steel cleaning cloths are practical and efficient for cleaning surfaces. Made with soft, absorbent fabric, it is already dampened with a cleansing solution. With cleaning function and anti-tarnish action, they can be used to clean glass, lenses, screens, box, stainless steel, sinks and washable surfaces, because they dry quickly and leave no stains.

Composition: 80% polyester and 20% viscose

Reference	Measure	Grammage	Code Bars	Packing
SP17000	20x17cm	45 g/m ²	7908057000758	Box with 9 units
SP17000R	20x17cm	45 g/m ²	7908057000765	Box with 12 units



MULTI-USE DISINFECTANT WET CLOTH

This product is 99.9% effective in eliminating bacteria such as salmonella, choleraesuis, staphylococcus aureus, pseudomonas aeruginosa and escherichia coli. More practicality in professional cleaning. Made with soft, absorbent fabric, they come already dampened with a total cleansing solution.

Its special formula allows complete cleaning with prolonged action.

Composition: 80% polyester and 20% viscose

Reference	Measure	Grammage	Code Bars	Packing
SP17100	20cm x 16.5cm	45 g/m ²	7908057000772	Box with 4 units
SP17100R	20cm x 16.5cm	45 g/m ²	7908057000789	Box with 6 units



SuperPro Rolls and Cloths are very versatile. They wash, wipe and shine. They turn daily tasks more practical and dynamic. Available in different colors, weights and sizes, they are suitable for all types of cleaning.

SuperPro
* BETANIN



DEGREASING MOISTENED CLOTH

Practical and efficient in cleaning surfaces with grease. Made with soft, absorbent fabric, they come already dampened with a total cleansing solution. Its balanced formula allows for quick and easy adherence and total fat dissolution. Its degreasing formula acts instantly.
Composition: 80% polyester and 20% viscose.

Reference	Measure	Grammage	Code Bars	Packing
SP17101	20cm x 16.5cm	45 g/m ²	7908057000796	Box with 4 units
SP17101R	20cm x 16.5cm	45 g/m ²	7908057000802	Box with 6 units



HEAVY CLEANING WET CLOTH

SuperPro Heavy Dip Wipes are practical and efficient in cleaning surfaces. Made with soft, absorbent fabric, they come already dampened with a total cleansing solution efficient in heavy dirt environments.
Practical and efficient, suitable for general surfaces.

Reference	Measure	Grammage	Code Bars	Packing
SP17102	20cm x 16.5cm	45 g/m ²	7908057000819	Box with 4 units
SP17102R	20cm x 16.5cm	45 g/m ²	7908057000826	Box with 6 units



> Rolls and Cloths

ROLL NONWOVEN FABRIC 35G/M²

Contains 750 cloths. Tear off every 40 cm.
Composition: 20% viscose and 80% polyester

Color	Reference	Measure	Grammage	Code Bars	Packing
White	SP2040BR	300m X 28,5cm	35 g/m ²	7898509286901	Bag with 1 unit
Orange	SP2040LR	300m X 28,5cm	35 g/m ²	7898509286871	Bag with 1 unit
Blue	SP2040AZ	300m X 28,5cm	35 g/m ²	7898509286888	Bag with 1 unit
Green	SP2040VD	300m X 28,5cm	35 g/m ²	7898509286895	Bag with 1 unit

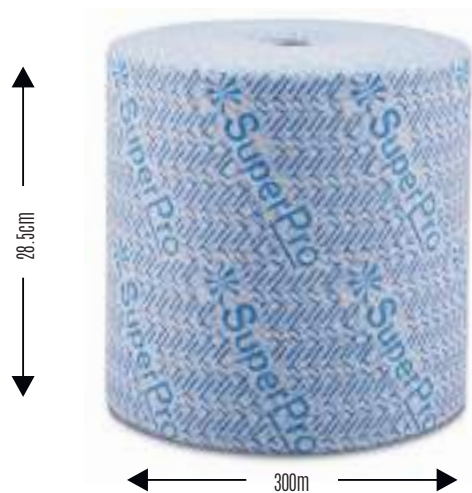

ROLL NONWOVEN FABRIC 40G/M²

Contains 600 cloths. Tear off every 50 cm.
Composition: 50% viscose and 50% polyester

Color	Reference	Measure	Grammage	Code Bars	Packing
White	SP2050BR	300m X 20cm	40 g/m ²	7898509287229	Bag with 1 unit
Orange	SP2050LR	300m X 20cm	40 g/m ²	7898509287199	Bag with 1 unit
Blue	SP2050AZ	300m X 20cm	40 g/m ²	7898509287205	Bag with 1 unit
Green	SP2050VD	300m X 20cm	40 g/m ²	7898509287212	Bag with 1 unit

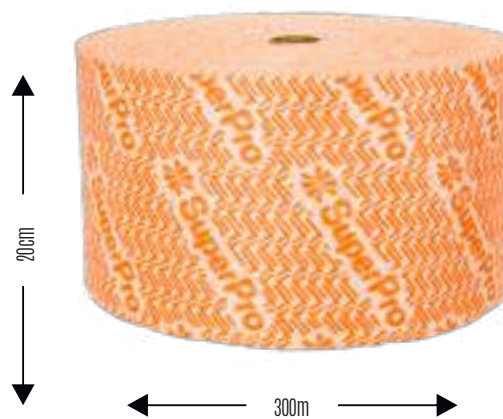

ROLL NONWOVEN FABRIC 35G/M²

Contains 600 cloths. Tear off every 40 cm.
Composition: 20% viscose and 80% polyester

Color	Reference	Measure	Grammage	Code Bars	Packing
White	SP2840BR	240m X 28,5cm	35 g/m ²	7898509287021	Bag with 1 unit
Orange	SP2840LR	240m X 28,5cm	35 g/m ²	7898509286994	Bag with 1 unit
Blue	SP2840AZ	240m X 28,5cm	35 g/m ²	7898509287007	Bag with 1 unit
Green	SP2840VD	240m X 28,5cm	35 g/m ²	7898509287014	Bag with 1 unit

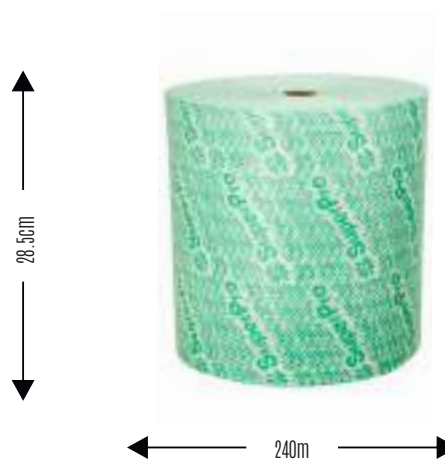



ROLL NONWOVEN FABRIC 35G/M²

Contains 60 cloths. Tear off every 50 cm.
Composition: 20% viscose and 80% polyester.

Color	Reference	Measure	Grammage	Code Bars	Packing
White	SP303530BR	30x0.30m	35 g/m ²	7898509288882	Box with 12 units
Orange	SP303530LR	30x0.30m	35 g/m ²	7898509288608	Box with 12 units
Blue	SP303530AZ	30x0.30m	35 g/m ²	7898509288875	Box with 12 units
Green	SP303530VD	30x0.30m	35 g/m ²	7898509288615	Box with 12 units

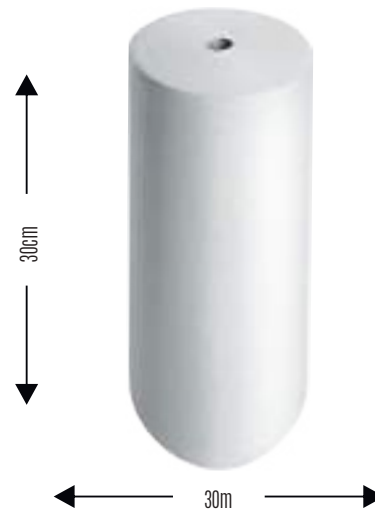

ROLL NONWOVEN FABRIC 35G/M²

Contains 600 cloths. Tear off every 50 cm.
Composition: 20% viscose and 80% polyester

Color	Reference	Measure	Grammage	Code Bars	Packing
White	SP3035BR	30x0.30m	35 g/m ²	7898509288578	Bag with 1 unit
Orange	SP3035LR	30x0.30m	35 g/m ²	7898509288011	Bag with 1 unit
Blue	SP3035AZ	30x0.30m	35 g/m ²	7898509288561	Bag with 1 unit
Green	SP3035VD	30x0.30m	35 g/m ²	7898509288004	Bag with 1 unit

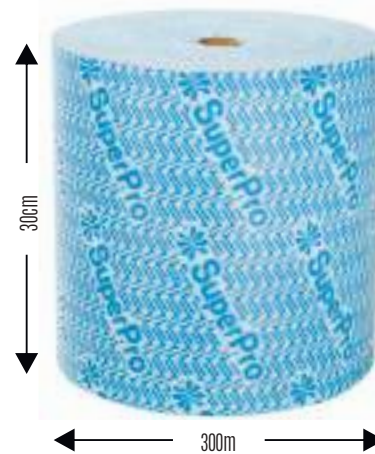

MULTIUSE NON WOVEN FABRIC 35G/M²

Assists in the removal of fat and dry stoves, sinks and tiles. For washing, use the detergent of your choice, if necessary, and squeeze it to lather. To rinse it, place under running water and continue to squeeze it gently.
Composition: 50% viscose and 50% polyester.

Color	Reference	Measure	Grammage	Code Bars	Packing
Blue	SP304501	50x30cm	35g	7898509287113	Box with 25 units



> Rolls and Cloths

ROLL NONWOVEN FABRIC 45G/M²

Contains 60 cloths. Tear off every 50 cm.
Composition: 70% viscose and 30% polyester.

Color	Reference	Measure	Grammage	Code Bars	Packing
White	SP304530BR	30x0.30m	45 g/m ²	7898509287182	Box with 12 units
Orange	SP304530LR	30x0.30m	45 g/m ²	7898509287151	Box with 12 units
Blue	SP304530AZ	30x0.30m	45 g/m ²	7898509287168	Box with 12 units
Green	SP304530VD	30x0.30m	45 g/m ²	7898509287175	Box with 12 units

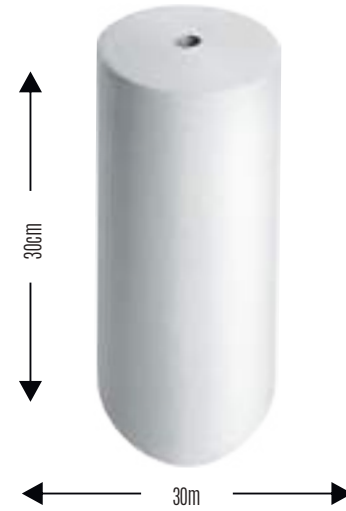

ROLL NONWOVEN FABRIC 45G/M²

Contains 600 cloths. Tear off every 50 cm.
Composition: 70% viscose and 30% polyester.

Color	Reference	Measure	Grammage	Code Bars	Packing
White	SP3045BR	30x0.30m	45g/m ²	7898509287106	Bag with 1 unit
Orange	SP3045LR	30x0.30m	45g/m ²	7898509287076	Bag with 1 unit
Blue	SP3045AZ	30x0.30m	45g/m ²	7898509287083	Bag with 1 unit
Green	SP3045VD	30x0.30m	45g/m ²	7898509287090	Bag with 1 unit

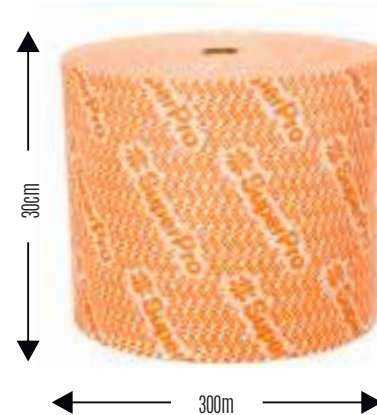

ROLL NONWOVEN FABRIC 40G/M²

Contains 60 cloths. Tear off every 50 cm.
Composition: 50% viscose and 50% polyester.

Color	Reference	Measure	Grammage	Code Bars	Packing
White	SP305030BR	30m x 0.30m	40 g/m ²	7898509288158	Box with 12 units
Orange	SP305030LR	30m x 0.30m	40 g/m ²	7898509288127	Box with 12 units
Blue	SP305030AZ	30m x 0.30m	40 g/m ²	7898509288141	Box with 12 units
Green	SP305030VD	30m x 0.30m	40 g/m ²	7898509288134	Box with 12 units

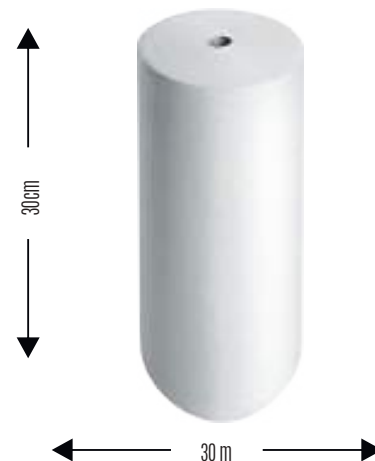



ROLL NONWOVEN FABRIC 35G/M²

Roll of nonwoven fabric: cellulose and polyester.

Color	Reference	Measure	Grammage	Code Bars	Packing
White	SP355025BR	30m x 0.25m	35 g/m ²	7908057000055	Box with 12 units
Orange	SP355025LR	30m x 0.25m	35 g/m ²	7908057000048	Box with 12 units
Blue	SP355025AZ	30m x 0.25m	35 g/m ²	7908057000024	Box with 12 units
Green	SP355025VD	30m x 0.25m	35 g/m ²	7908057000031	Box with 12 units

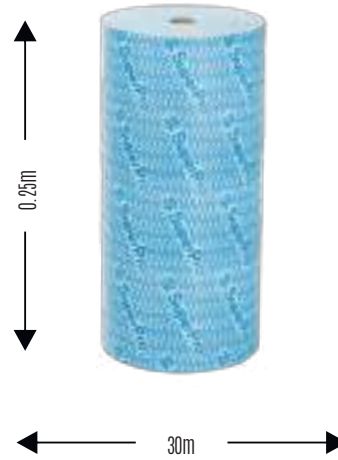

ROLL NONWOVEN FABRIC 40G/M²

Contains 600 cloths. Tear off every: 50 cm.
Composition: 50% viscose and 50% polyester

Color	Reference	Measure	Grammage	Code Bars	Packing
White	SP3050BR	300m x 0.30m	40 g/m ²	7898509287267	Bag with 1 unit
Orange	SP3050LR	300m x 0.30m	40 g/m ²	7898509287236	Bag with 1 unit
Blue	SP3050AZ	300m x 0.30m	40 g/m ²	7898509287243	Bag with 1 unit
Green	SP3050VD	300m x 0.30m	40 g/m ²	7898509287250	Bag with 1 unit



PRO SLIM ROLL 35G/M²

Contains 750 cloths. Tear off every 40 cm.
Composition: 50% cellulose and 50% polyester

Color	Reference	Measure	Grammage	Code Bars	Packing
White	SP3528BR	28cmx300m	35 g/m ²	7908057001106	Bag with 1 unit
Orange	SP3528LR	28cmx300m	35 g/m ²	7908057001083	Bag with 1 unit
Blue	SP3528AZ	28cmx300m	35 g/m ²	7908057001076	Bag with 1 unit
Green	SP3528VD	28cmx300m	35 g/m ²	7908057001090	Bag with 1 unit

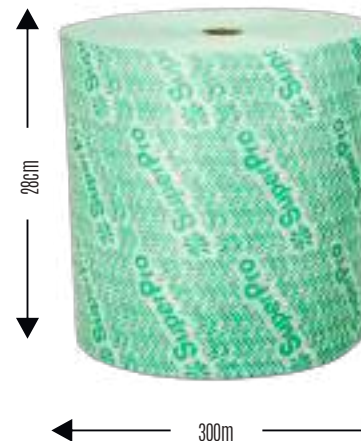

> Rolls and Cloths

PANTEC SUPERPRO IN PACKAGES 50G/M²

Pantec SuperPro cloths do not release lint, avoiding rework and providing agility to the cleaning process. It reduces the risk of contamination of products, equipment and work surfaces. Suitable for cleaning surfaces that require rigorous cleaning. Composition: 65% viscose and 35% polyester.

Color	Reference	Measure	Grammage	Code Bars	Packing
● White	SP50400BR	30x38cm	50 g/m ²	7898509288202	8 packages with 50 units



PANTEC SUPERPRO ROLL 60G/M²

Pantec has great absorption power, does not loose fragments and has high resistance to chemicals. Contains 500 cloths. Tear off every 38 cm.

Color	Reference	Measure	Grammage	Code Bars	Packing
● White	SP60190BR	190m x 30m	60 g/m ²	7898509288196	Bag with 01 unit

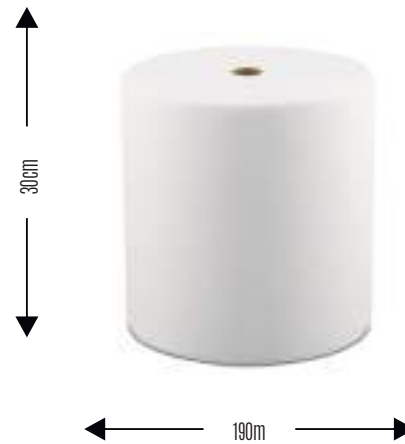

PROPELL SUPERPRO IN PACKAGES 50G/M²

Suitable for cleaning surfaces, utensils, parts, equipment, solvents, liquid applications and general use. High performance liquid cleaning product, solvent resistant and high tear resistance. It presents low particle release as well as high and fast absorption. They are autoclaved in configurations, being able to withstand pressures of up to 10 kgf/cm² and temperatures up to 110 ° C. High absorption, disposable, low contamination and lint release. Composition: 70% cellulose and 30% polypropylene

Color	Reference	Measure	Grammage	Code Bars	Packing
● White	SP80100BR	28cm x 35cm	50 g/m ²	7898509288813	8 packages with 100 units





PROPELL SUPERPRO IN ROLLS 50G/M²

Suitable for cleaning surfaces, utensils, parts, equipment, solvents, liquid applications and general use. High performance liquid cleaning product, solvent resistant and high tear resistance. It presents low particle release as well as high and fast absorption. They are autoclaved in configurations, being able to withstand pressures of up to 10 kgf/cm² and temperatures up to 110 ° C. High absorption, disposable, low contamination and lint release. Composition: 70% cellulose and 30% polypropylene. Contains 416 cloths. Tear off every 43.5 cm.

Color	Reference	Measure	Grammage	Code Bars	Packing
White	SP80416BR	24.5cm x 43.5cm	50 g/m ²	7898509288806	Bag with 1 unit



PROPELL SUPERPRO IN PACKAGES 60G/M²

Suitable for cleaning surfaces, utensils, parts, equipment, solvents, liquid applications and general use. High performance liquid cleaning product, solvent resistant and high tear resistance. It presents low particle release as well as high and fast absorption. They are autoclaved in configurations, being able to withstand pressures of up to 10 kgf/cm² and temperatures up to 110 ° C. High absorption, disposable, low contamination and lint release.

Composition: 70% cellulose and 30% polypropylene

Color	Reference	Measure	Grammage	Code Bars	Packing
White	SP80101BR	28cm x 35cm	60 g/m ²	7908057000901	8 packages with 100 units

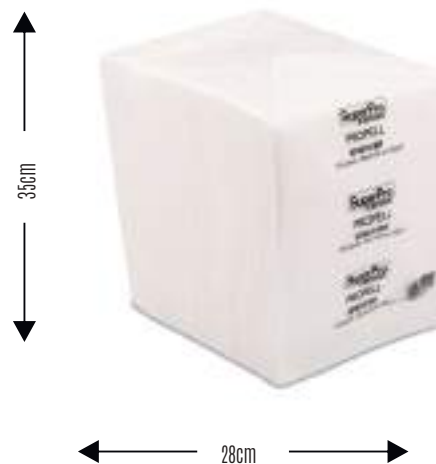

MULTI-USE MICROFIBER CLOTH

Composition: 84% polyester and 16% polyamide

Color	Reference	Measure	Grammage	Code Bars	Packing
Mix	SP9324	35x35cm	250 g/m ²	7898509287762	Box of 8 packages with 4 units
Yellow	SP9324AM	35x35cm	250 g/m ²	7898509289544	Box of 8 packages with 4 units
Red	SP9324VR	35x35cm	250 g/m ²	7898509289551	Box of 8 packages with 4 units
Blue	SP9324AZ	35x35cm	250 g/m ²	7898509289520	Box of 8 packages with 4 units
Green	SP9324VD	35x35cm	250 g/m ²	7898509289537	Box of 8 packages with 4 units





> Rolls and Cloths

GENTLE CLEAN MICROFIBER CLOTH

Composition: 84% polyester and 16% polyamide.

Color	Reference	Measure	Grammage	Code Bars	Packing
● Yellow	SP9326	30x40cm	200 g/m ²	7898509287779	Box with 12 units

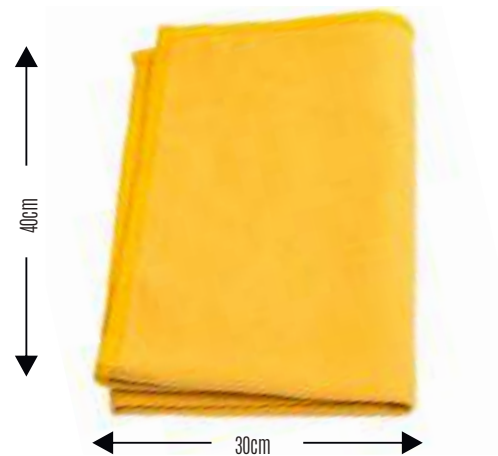

MICROFIBER CLOTH FOR GLASS CLEANING

Quick and efficient cleaning, soft, does not scratch, leaves no streaks or stains.

Composition: 84% polyester and 16% polyamide

Color	Reference	Measure	Grammage	Code Bars	Packing
● Beige	SP9327	60x40cm	280 g/m ²	7898509287786	Box with 8 units



MICROFIBER CLOTH GENERAL USE

Composition: polyester and polyamide.

Color	Reference	Measure	Grammage	Code Bars	Packing
● Gray	SP9328	70x50cm	200 g/m ²	7898509288219	Box with 12 units





SUPERPRO WHITE MULTI-PURPOSE MICROFIBER CLOTH

The Multipurpose Microfiber Cloth comes in an economical packaging, is washable and reusable, and has greater absorption. Product intended for cleaning surfaces in general. Absorbs up to 8X its weight.

Color	Reference	Measure	Grammage	Code Bars	Packing
White	SP9334BR	30x30cm	200 g/m ²	7908057000345	Box with 50 units



PVA MULTI-USE MAGIC CLOTH

Product developed in PVA with high absorption power.

Color	Reference	Measure	Grammage	Code Bars	Packing
Blue	SP9331	43x65cm	160g	7898509287816	Box with 10 units



ECO PRO MICROFIBER CLOTH

Easy to slip, can be used dry or wet; washable, does not scratch and has good absorption.

Color	Reference	Measure	Grammage	Code Bars	Packing
Gray and White	SP9322	50x40cm	160 g/m ²	7898509286123	8 packages with 3 units each

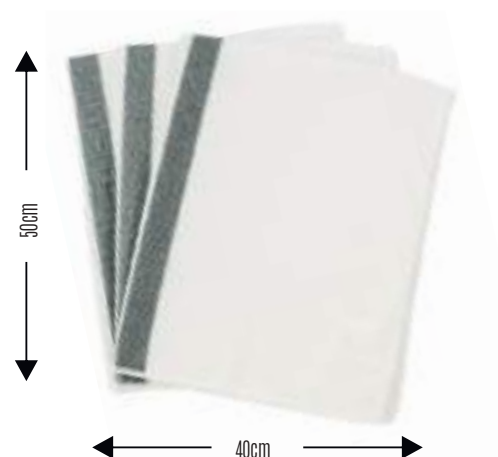

> Rolls and Cloths

MICROFIBER CLOTH GENERAL USE

Composition: 85% polyester and 15% polyamide
Great absorption, may be used dry or wet. Removes and retains dust without spreading dirt. Does not scratch and does not release residues.

Color	Reference	Measure	Grammage	Code Bars	Packing
● Green	SP9321	30x32cm	450g/m ²	7898509286116	8 packages with 3 units each.



LIMP PRO MICROFIBER CLOTH

Fast and efficient drying, high absorption power.
May be used dry or wet.

Color	Reference	Measure	Grammage	Code Bars	Packing
● Green	SP9323	60x40cm	285 g/m ²	7898509286130	Box with 24 units

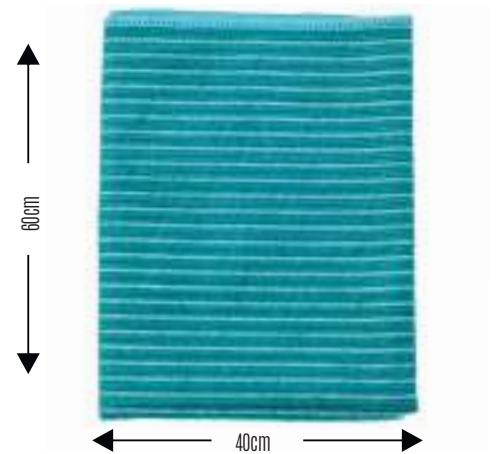

METAL HOLDER FOR ROLL 300M

With a distinctive design, the roll holder is easy to install.
Suitable for 20cm and 30cm wide coils.

Color	Reference	Measure	Weight	Code Bars	Packing
● White	SP9345	315mm x Ø 380mm	830g	7898509283818	Box with 2 unit





UNIVERSAL METAL HOLDER FOR ROLL CLOTH

With a distinctive design, the roll holder is easy to install.
Suitable for 20cm and 30cm wide coils.

Color	Reference	Measure	Weight	Code Bars	Packing
● White	SP9325	220mm x 110mm x 80mm	435g	7898509287304	Box with 1 unit



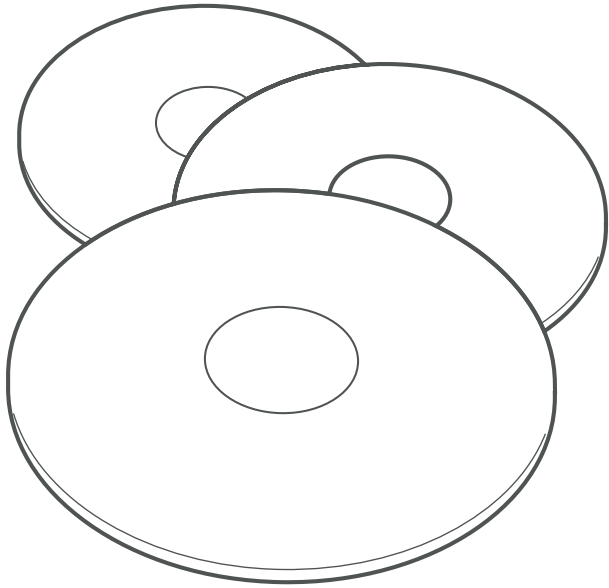

Floor Discs

BLACK REMOVER

For removal of all finish, sealer and floor contaminants.
Use it for maintenance or when conventional cleaning does not provide the desired result. Great durability.

Color	Reference	Measure	Weight	Code Bars	Packing
● Black	9630	30cm	130g	7898509281289	Box with 20 units
● Black	9635	35cm	170g	7898509281296	Box with 20 units
● Black	9638	38cm	200g	7898509281302	Box with 20 units
● Black	9641	41cm	230g	7898509281319	Box with 20 units
● Black	9644	44cm	270g	7898509281326	Box with 20 units
● Black	9651	51cm	360g	7898509281333	Box with 20 units
● Black	SP9635CA	35cm	170g	7898509285744	Box with 10 units
● Black	SP9641CA	41cm	230g	7898509285751	Box with 10 units
● Black	SP9651CA	51cm	360g	7898509285768	Box with 10 units



Disc	Operation	Rotation	RPM	Yield	Material	Abrasive	Grain
● Black	Total Removal	Low	175/300 pm	3.000m ² - 4.000m ²	Nylon	A	240
● Green	Cleaning and Maintenance	Low	175/300 pm	5.000m ² - 6.000m ²	Nylon	A	240
● Red	Cleaning and Polishing	Low	175/300 pm	5.000m ² - 6.000m ²	Nylon - Polyester		
● Brown	Dry and wet polishing	Low	175/300 pm	7.000m ² - 8.000m ²	Polyester		
● Champagne	Dry and wet polishing	Low	175/300 pm	7.000m ² - 8.000m ²	Polyester		
● White	Polishing	Low	175/300 pm	7.000m ² - 8.000m ²	Polyester		

Floor disks are based on synthetic fiber and each abrasiveness is differentiated by one color (darker to clean and remove, lighter to buff and polish).

This line caters for all steps of floor treatment, from removal and cleaning to polishing and restoration, as well as varying sizes, adapting to various types of floor polishers.

DISC COLORS ALSO INDICATE THEIR FUNCTION:



◀ **DARK DISCS:**
Designed to clean and remove surface dirt.

◀ **LIGHT DISCS:**
Designed to sleek and polish surfaces.

GREEN CLEANER

All types of floors except the most fragile such as porcelain tiles. Made abrasive in its composition, facilitates the removal of superficial layers and impregnated dirt.

Color	Reference	Measure	Weight	Code Bars	Packing
● Green	9830	30cm	110g	7898509281456	Box with 20 units
● Green	9835	35cm	150g	7898509281463	Box with 20 units
● Green	9838	38cm	180g	7898509281470	Box with 20 units
● Green	9841	41cm	210g	7898509281487	Box with 20 units
● Green	9844	44cm	240g	7898509281494	Box with 20 units
● Green	9851	51cm	320g	7898509281500	Box with 20 units
● Green	SP9835CA	35cm	150g	7898509285577	Box with 10 units
● Green	SP9841CA	41cm	210g	7898509285584	Box with 10 units
● Green	SP9851CA	51cm	320g	7898509285591	Box with 10 units



> Floor Discs

RED RESTORATOR

Enhances the appearance of the floor without damaging the finish.

Color	Reference	Measure	Weight	Code Bars	Packing
● Red	11030	30cm	100g	7898509285164	Box with 20 units
● Red	11035	35cm	140g	7898509280046	Box with 20 units
● Red	11038	38cm	150g	7898509280053	Box with 20 units
● Red	11041	41cm	180g	7898509280060	Box with 20 units
● Red	11044	44cm	210g	7898509280077	Box with 20 units
● Red	11051	51cm	320g	7898509280084	Box with 20 units
● Red	SP11035CA	35cm	140g	7898509285706	Box with 10 units
● Red	SP11041CA	41cm	180g	7898509285713	Box with 10 units
● Red	SP11051CA	51cm	320g	7898509285720	Box with 10 units



BROWN POLISHER

Enhances the appearance of the floor without damaging the finish.

Color	Reference	Measure	Weight	Code Bars	Packing
● Brown	9735	35cm	150g	7898509281401	Box with 20 units
● Brown	9738	38cm	170g	7898509281418	Box with 20 units
● Brown	9741	41cm	190g	7898509281425	Box with 20 units
● Brown	9744	44cm	230g	7898509281432	Box with 20 units
● Brown	9751	51cm	300g	7898509281449	Box with 20 units



CHAMPAGNE LUSTER

Enhances the appearance of the floor without damaging the finish.

Color	Reference	Measure	Weight	Code Bars	Packing
● Champagne	12030	30cm	90g	7898509285171	Box with 20 units
● Champagne	12035	35cm	130g	7898509280091	Box with 20 units
● Champagne	12041	41cm	160g	7898509280114	Box with 20 units
● Champagne	12051	51cm	260g	7898509280138	Box with 20 units





WHITE LUSTER

Suitable for polishing without removing the finish.

Color	Reference	Measure	Weight	Code Bars	Packing
White	9935	35cm	120g	7898509281517	Box with 20 units
White	9938	38cm	140g	7898509281524	Box with 20 units
White	9941	41cm	180g	7898509281531	Box with 20 units
White	9944	44cm	210g	7898509281548	Box with 20 units
White	9951	51cm	280g	7898509281555	Box with 20 units
White	SP9935CA	35cm	120g	7898509285607	Box with 10 units
White	SP9941CA	41cm	180g	7898509285614	Box with 10 units
White	SP9951CA	51cm	280g	7898509285621	Box with 10 units



PIG FUR DISC

Suitable for polishing floors with acrylic finishes in places of heavy traffic.

Color	Reference	Measure	Weight	Code Bars	Packing
Beige	13505	50.5cm	250g	7898509283221	Box with 10 units
Beige	13685	68.5cm	460g	7898509283238	Box with 10 units



CHAMPAGNE HS DISC

Restores the brightness of floors with acrylic finishes and fixes newly applied finishes.

Color	Reference	Measure	Weight	Code Bars	Packing
Champagne	14505	50.5cm	240g	7898509283245	Box with 10 units
Champagne	14685	68.5cm	470g	7898509283252	Box with 10 units



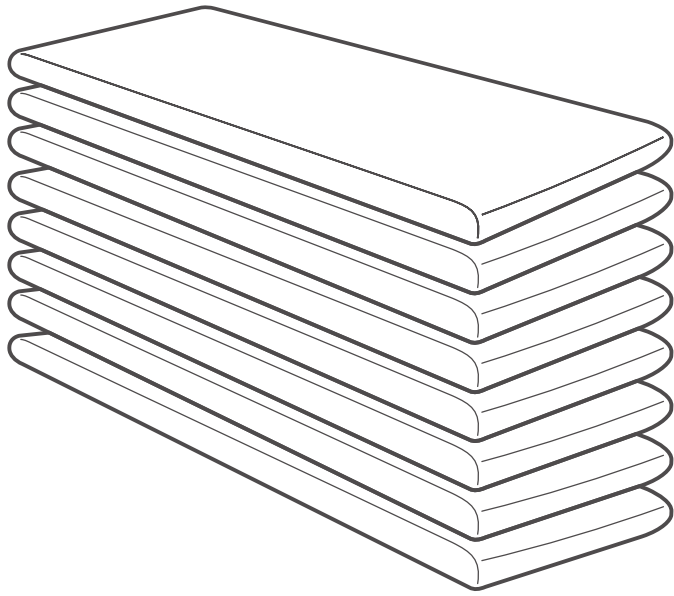

Fibers

FIBER CLEANING BETAÇO 1X20X10

Suitable for highly adherent cleaning, such as carbonized grease fouling, oxidation, removal of finishes and coarse materials. Abrasive product.

Color	Reference	Measure	Grammage	Code Bars	Packing
● Blue	9500	12.5x8.7cm	1180g/m ²	7898509281166	20 packages with 10 units
● Blue	SP9500/1	12.5x8.7cm	1180g/m ²	7898509286437	Box with 80 units
● Blue	9508	26x10.2cm	1,700g/m ²	7898509281241	Box with 100 units



BETAÇO SLIM FINE FIBER 1X20X10

Suitable for highly adherent cleaning, such as carbonized grease fouling, oxidation, removal of finishes and coarse materials. Abrasive product.

Color	Reference	Measure	Grammage	Code Bars	Packing
● Blue	9521	12.5x8.7cm	1,100g/m ²	7898509283436	Box with 200 units

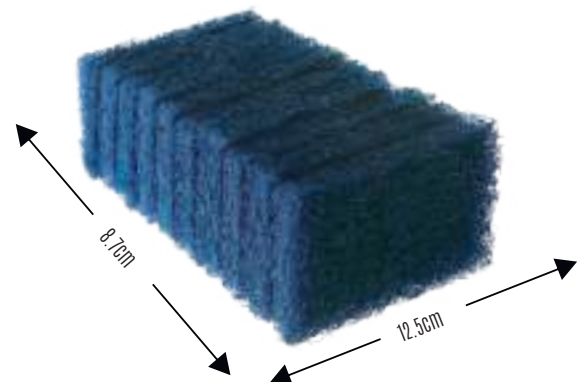

Produced according to advanced technological standards, they allow for use in various areas, such as sheet metal floors, ovens, and industrial stoves. There are more than 10 types of fibers, each specific to a surface type or degree of dirt. Fiber holders are ergonomic and easy to handle, with variations which allow them to be used with or without handles, facilitating cleaning on surfaces with varying temperatures and ranges, as well as ensuring the safety and welfare of the user.



ULTRA HEAVY FIBER 1X10X10

Suitable for highly adherent cleaning, such as carbonized grease fouling, oxidation, removal of finishes and coarse materials. Abrasive product.

Color	Reference	Measure	Grammage	Code Bars	Packing
● Black	SP9527	260mm x 102mm	950g/m ²	7908057000390	10 packages with 10 units



HEAVY CLEANING FIBER 102X260 1X10X10

Indicated for cleaning with greater difficulty of removal, such as pans, grills, plates or end-of-work cleaning. Abrasive product.

Color	Reference	Measure	Grammage	Code Bars	Packing
● Green	9505	24X13cm	620g/m ²	7898509281227	10 packages with 100 units
● Green	9506	26x10.2cm	620g/m ²	7898509281234	10 packages with 10 units
● Green	SP9506/2	22.5x10.1cm	620g/m ²	7898509286468	50 packages with 2 units





> Fibers

HEAVY CLEANING SLIM FIBER 1X10X12

Indicated for cleaning with greater difficulty of removal, such as pans, grills, plates or end-of-work cleaning. Abrasive product.

Color	Reference	Measure	Grammage	Code Bars	Packing
Green	SP9526FR	22.5x10.1cm	600 g/m ²	7908057000154	12 packages with 10 units

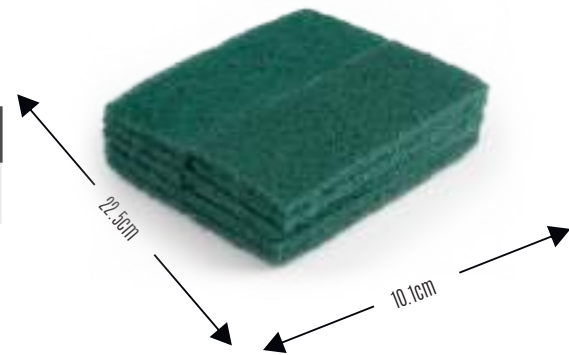

MULTI PURPOSE CLEANING FIBER 102X260 1X10X10

Indicated for general cleaning of utensils, as long as not polished. Abrasive product, ideal for effectively removing medium dirt such as equipment, floors and surfaces.

Color	Reference	Measure	Grammage	Code Bars	Packing
Green	9502	26x10.2cm	630g/m ²	7898509281180	Box with 100 units
Green	SP9502/3	22.5x10.1cm	630g/m ²	7898509286444	Box of 40 units with 3 each



GENERAL PURPOSE SLIM FIBER 1X10X12

Suitable for general cleaning of surfaces such as floors, walls, countertops, equipment and utensils. Used in industrial kitchens, restaurants, bars, bakeries, hotels, fast food and food industries.

Color	Reference	Measure	Grammage	Code Bars	Packing
Green	9522FR	22.5x10.1cm	760 g/m ²	7898509281272	Box with 120 units

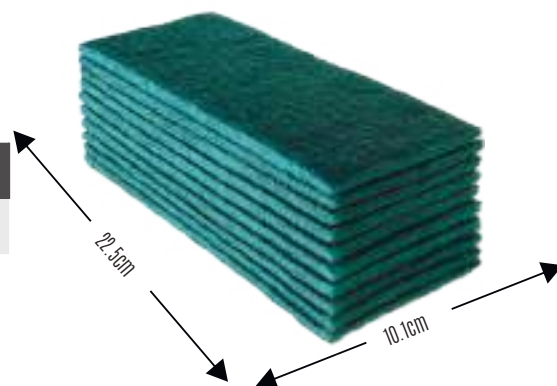



LIGHT CLEANING FIBER 102X260 1X10X10

Suitable for delicate surfaces requiring care in cleaning because it has no abrasive. It doesn't scratch.

Color	Reference	Measure	Grammage	Code Bars	Packing
● White	9504	26x10.2cm	360g/m ²	7898509281210	10 packages with 10 units
● White	SP9504/3	26x10.2cm	360g/m ²	7898509286451	40 packages with 3 units

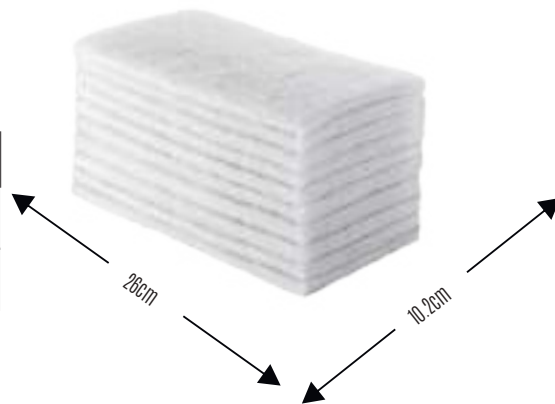

LIGHT CLEANING SLIM FIBER 1X10X12

Suitable for delicate surfaces requiring care in cleaning because it has no abrasive. It doesn't scratch.

Color	Reference	Measure	Grammage	Code Bars	Packing
● White	SP9523FR	22.5x10.1cm	300g/m ²	7898509287991	12 packages with 10 units



BLUE LIGHT CLEANING FIBER 1X80

Waterproof, nonstick resin. Suitable for delicate cleaning, teflon surfaces, dairy industry. Non-abrasive product.

Color	Reference	Measure	Grammage	Code Bars	Packing
● Blue	9509	26x10.2cm	550g/m ²	7898509281258	Box with 100 units
● Blue	SP9509/3	26x10.2cm	550 g/m ²	7898509286475	Box with 40 units

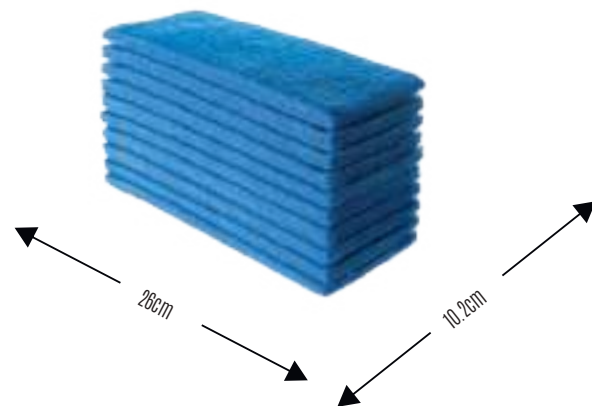



RED FIBER 1X100

Masonry finishing, grout cleaning, wood finishing, rust removal, oxidation marks and metal part finishing.

Color	Reference	Measure	Grammage	Code Bars	Packing
● Red	9409	22.5x15cm	760g/m ²	7898509280978	Box with 100 units

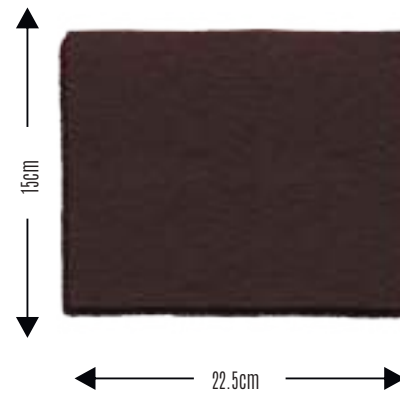

GRAY ASF FIBER 1X10X10 GRA0400

Abrasive fiber that provides fast and consistent finishing on metal and wood parts.

Color	Reference	Measure	Grammage	Code Bars	Packing
● Gray	9513	26x10.2cm	530g/m ²	7898509281265	Box with 100 units

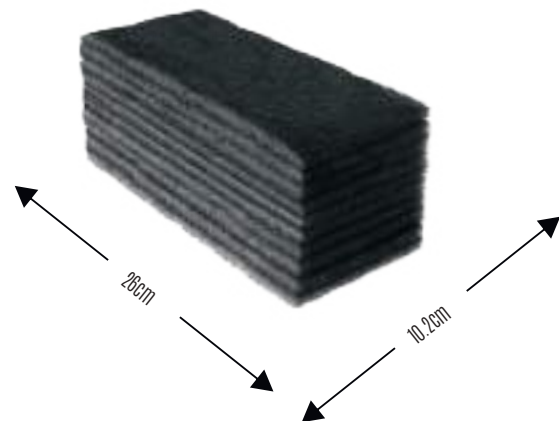

FIBER HOLDER BT/LT 1X10

Ideal for long range cleanings such as ceilings, walls, facades, etc. Compatible with Ø 22 mm and Ø 25 mm handles.

Color	Reference	Measure	Weight	Code Bars	Packing
● Gray	9516	22.5cm x 9.3cm x 5.7cm	97g	7898509282187	Box with 10 units

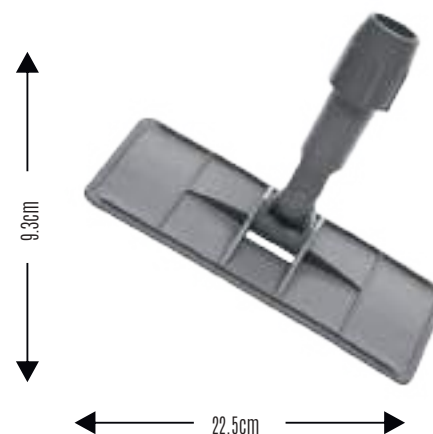



FIBER MANUAL HOLDER 1X10

Ideal for cleaning broad areas together with the ideal fiber for each surface.

Color	Reference	Measure	Weight	Code Bars	Packing
● Gray	SP9517	22.5cm x 9.2cm x 5.2cm	82g	7898509284495	Box with 10 units



BETTAÇO MANUAL HOLDER 1X10

Suitable for use with Bettaço fiber. Ideal for plate cleaning, thus avoiding direct contact with hot surfaces.

Color	Reference	Measure	Weight	Code Bars	Packing
● Gray	9515	11cm x 8cm x 5.5cm	56g	7898509282170	Box with 10 units



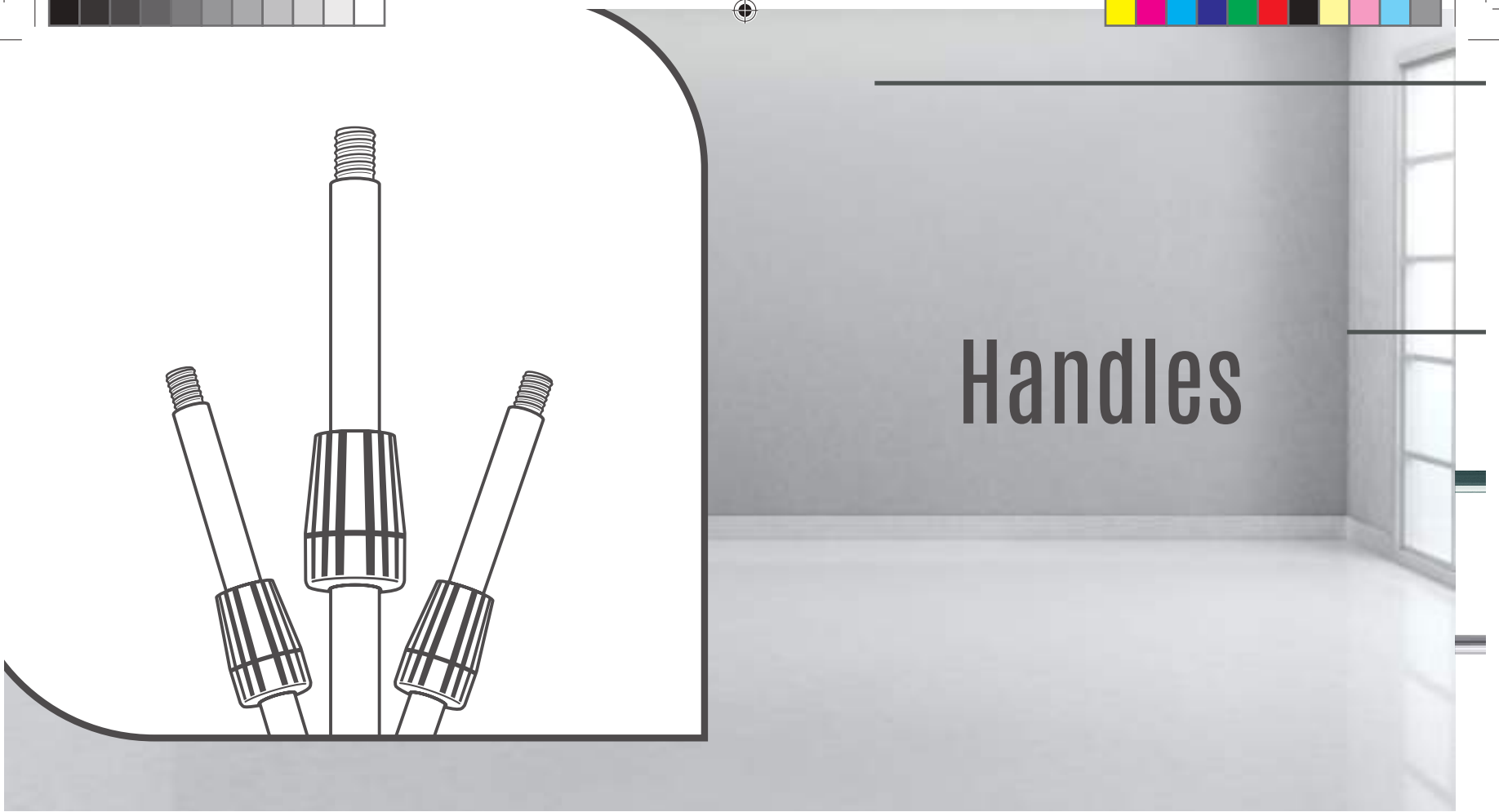

STEEL HANDLE W/ THREAD

Handle made of sheet steel with a thread diameter of 25 mm.

Color	Reference	Measure	Weight	Code Bars	Packing
● Gray	9010	150cm x Ø 2.5cm	326g	7898509280220	Bag with 12 unit
● Gray	9012	130cm x Ø 2.5cm	266g	7898509280237	Bag with 12 unit

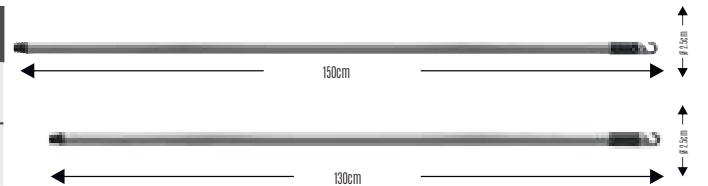

Steel Handle 1.20 m with Thread

Handle made of sheet steel 1.20 m long with a thread diameter of 22 mm.

Color	Reference	Measure	Weight	Code Bars	Packing
● Gray	9015	120cm x Ø 2.2cm	198g	7898509280268	Bag with 12 unit

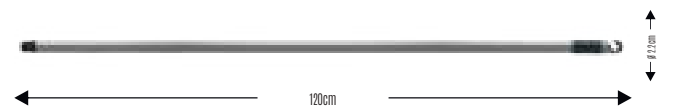

ALUMINUM HANDLE

Cable made of aluminum plate 1.50 m long. Ideal for LT mounts and wet mop mounts.

Color	Reference	Measure	Weight	Code Bars	Packing
● Silver	9014	150cm x Ø 2.5cm	416g	7898509280251	Bag with 6 unit
● Silver	9019	150cm x Ø 2.2cm	385g	7898509280282	Bag with 6 unit

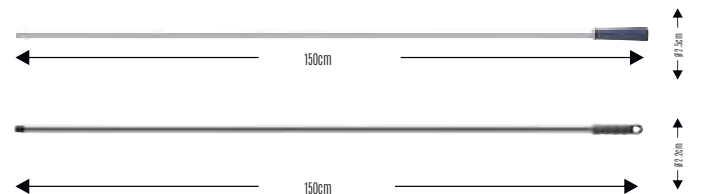

Bettanin Superpro presents handles of different designs and specifications in order to meet your needs. Steel, aluminum, color-coded and extension handles.

SuperPro
* BETTANIN



STEEL PLATE EXTENSOR HANDLE

Steel wire extension handle with maximum lengths of 2 and 3m and diameter of 22 mm.

Color	Reference	Measure	Weight	Code Bars	Packing
● Black	9032	200cm x Ø 2.2cm	436g	7898509280305	Bag with 6 unit
● Black	9033	300cm x Ø 2.2cm	710g	7898509280312	Bag with 6 unit

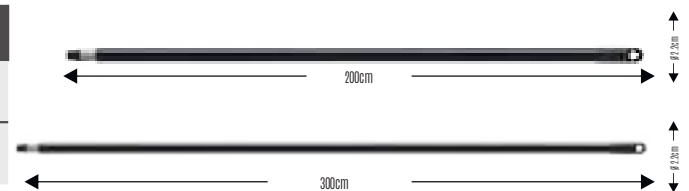

ALUMINUM HANDLE 140CM

Handle made of a smooth aluminum plate 1.40 m in length and 2.2 cm in diameter. Color coded handles to prevent cross contamination. Handles come with tapered bushing included.

Color	Reference	Measure	Weight	Code Bars	Packing
● Yellow and Silver	SP9010AM	140 cm x Ø 2.2cm	175g	7898509284716	Box with 6 units
● Blue and Silver	SP9010AZ	140 cm x Ø 2.2cm	175g	7898509284693	Box with 6 units
● Green and Silver	SP9010VD	140 cm x Ø 2.2cm	175g	7898509284709	Box with 6 units
● Red and Silver	SP9010VR	140 cm x Ø 2.2cm	175g	7898509284686	Box with 6 units

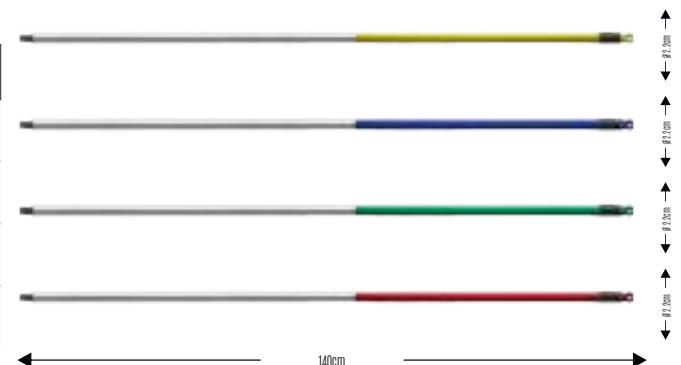

> Handles

STRIDED ALUMINUM HANDLE 140CM

Handle made of a stride aluminum plate 1.40 m in length and 2.2 cm in diameter. Color coded handles to prevent cross contamination. Handles come with tapered bushing included.

Color	Reference	Measure	Weight	Code Bars	Packing
 Silver and Yellow	SP9017AM	140 cm x Ø 2.2cm	216g	7898509288981	Box with 6 units
 Silver and Blue	SP9017AZ	140 cm x Ø 2.2cm	216g	7898509288950	Box with 6 units
 Silver and Green	SP9017VD	140 cm x Ø 2.2cm	216g	7898509288967	Box with 6 units
 Silver and Red	SP9017VR	140 cm x Ø 2.2cm	216g	7898509288974	Box with 6 units

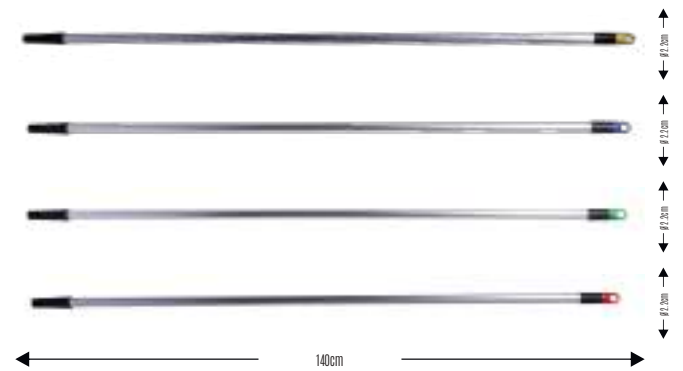

MULTIPURPOSE HANDLE PLATE

Handle made of sheet steel 1.40 m long with a thread diameter of 22 mm. Color coded handles to prevent cross contamination

Color	Reference	Measure	Weight	Code Bars	Packing
 Yellow	SP9020AM	140 cm x Ø 2.2cm	230g	7908057001175	Box with 12 units
 Blue	SP9020AZ	140 cm x Ø 2.2cm	230g	7898509289353	Box with 12 units
 Green	SP9020VD	140 cm x Ø 2.2cm	230g	7898509289377	Box with 12 units
 Red	SP9020VR	140 cm x Ø 2.2cm	230g	7898509289384	Box with 12 units
 Gray	SP9020CZ	140 cm x Ø 2.2cm	230g	7908057001052	Box with 12 units

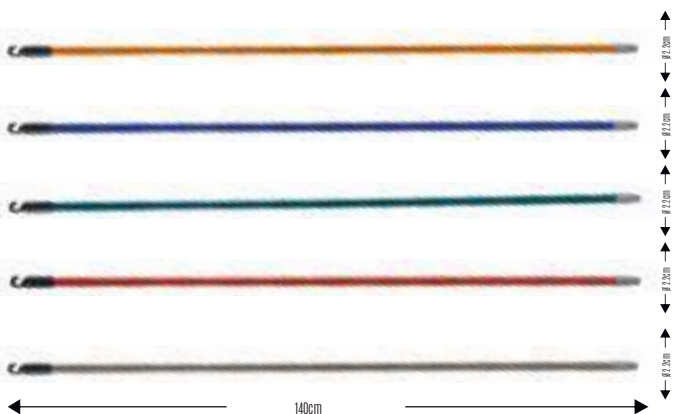

ALUMINUM HANDLE EXTENSION 140CM

Aluminum extension handle with 4,0 and 6,0 m in length and minimum diameter of 22 mm.

Color	Reference	Measure	Weight	Code Bars	Packing
 Silver	SP9034	400cm x Ø 2.2 cm	980g	7898509284914	Box with 6 units
 Silver	SP9036	600cm x Ø 2.2 cm	1.34Kg	7898509284921	Box with 6 units





ALUMINUM CAR WASHER HANDLE WITH WATER PASS

Suitable for use with the SP9687 brush.
Aluminum plate handle with water flow control.

Color	Reference	Measure	Weight	Code Bars	Packing
Silver and Black	SP9037	173cm x Ø 2.2cm	520g	7898509286062	Bag with 6 unit



CARWASH ALUMINUM HANDLE FOR SP9688 BRUSH

Water-pass aluminum plate handle for use with the SP9688 brush only.
Handle with water flow control.

Color	Reference	Measure	Weight	Code Bars	Packing
Silver and Black	SP9038	177cm x Ø 2.2cm	490g	7898509286079	Box with 4 units



MULTIPURPOSE ALUMINUM HANDLE

This cable presents water passage with flow limiting valve,
whether the user needs more or less water.
Aluminum foil handle ideal for use with the SP9689 mop.

Color	Reference	Measure	Weight	Code Bars	Packing
Silver	SP9689C	166cm x Ø 2.2cm	280g	7908057000451	1 unit



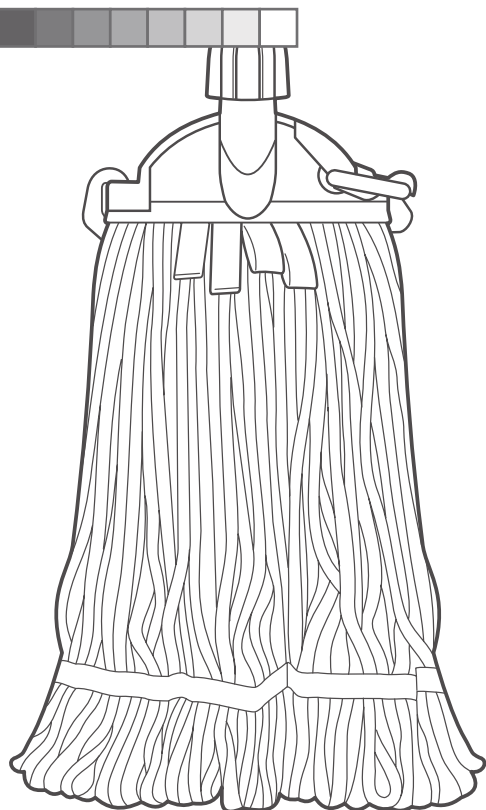

Mops and Holders

SYNTHETIC ACRYLIC POWDER MOP

Synthetic mop with electrostatic function, indicated for dry cleaning without raising dust. Not suitable for wax application.

Color	Reference	Measure	Weight	Code Bars	Packing
● Blue	9203	30cm x 16cm	150g	7898509280664	Box with 12 units
● Blue	9205	40cm x 16cm	220g	7898509280671	Box with 12 units
● Blue	9207	60cm x 16cm	270g	7898509283054	Box with 12 units
● Blue	9209	80cm x 16cm	360g	7898509280688	Box with 6 units



NATURAL COTTON POWDER MOP

Mop Cotton for dry cleaning without dusting.

Color	Reference	Measure	Weight	Code Bars	Packing
● Cream	9204	30cm x 15cm	150g	7898509281654	Box with 12 units
● Cream	9206	40cm X 15cm	220g	7898509281661	Box with 12 units
● Cream	9208	60cm X 15cm	270g	7898509281678	Box with 12 units
● Cream	9210	80cm X 15cm	360g	7898509281685	Box with 12 units



Available in a variety of sizes and materials, SuperPro mops enable the user to perform better and more productively while cleaning floors with wet mops and removing dust and dirt with powder mops.

SuperPro
* BETANIN



METAL FRAME FOR MOP POWDER

Used with 40 cm, 60 cm and 80 cm powder mops.
Compatible with handles of Ø 22 mm and Ø 25 mm.

Color	Reference	Measure	Weight	Code Bars	Packing
● Gray	9214	40x13cm	322g	7898509280718	Box with 6 units
● Gray	9215	60x13cm	382g	7898509280725	Box with 6 units
● Gray	9216	80x13cm	442g	7898509283375	Box with 6 units



PLASTIC HOLDER FOR MOP POWDER

Plastic Mop Holder, suitable for use with mops: 9211, 9203 and 9204.
Compatible with any threaded handle.

Color	Reference	Measure	Weight	Code Bars	Packing
● Gray	9220	30x10cm	95g	7898509280732	Box with 6 units



> Mops and Holders

SEKITO PVA MOP QUICK SHIFT

Washes and dries without scratching surfaces, besides being hygienic, as it prevents contact of hands with cleaning products. Refill gets easily changed, durable and economical. Extended handles up to 1.50 m.

Color	Reference	Measure	Weight	Code Bars	Packing
● Gray	9300F	150 x 30cm	916g	7898509283795	Box with 6 units
● Gray	SP9340F	150 x 40cm	1,230kg	7898509284679	Box with 6 units



SEKITO MOP PVA REFILL

Sekito 9300F and SP9340F Mops quick shift cartridge.

Color	Reference	Measure	Weight	Code Bars	Packing
● Gray	9300R	300mm x 50mm x 65mm	56g	7898509281760	Box with 6 units
● Gray	SP9340FR	400mm x 60mm x 65mm	226g	7898509286666	Box with 6 units



CUT TIP COTTON MOIST MOP

Mop cut tip, indicated for cleaning of cold floors. Compatible with any threaded handle.

Color	Reference	Measure	Weight	Code Bars	Packing
● Crude	9108P	420mm x 160mm	300g	7898509280435	Box with 12 units
● Crude	9109P	420mm x 160mm	340g	7898509280442	Box with 12 units
● Crude	9116P	139mm x 35mm x 370mm	260g	7898509282866	Box with 12 units





MOIST FOLDED TIP MOP

Moist folded tip mop at 300 g and 340 g, suitable for cleaning cold floors for use with stand and wringing bucket. Consisting of 80% cotton and 20% polyester. Suitable for broad areas. Most durability. Presents color coding for differentiation of environments and prevention of cross contamination. To be utilized with the 9224 holder.

Color	Reference	Measure	Weight	Code Bars	Packing
● Crude	SP9110P	42cm x 35cm	300g	7898509283672	Box with 12 units
● Crude	SP9111P	42cm x 35cm	340g	7898509283689	Box with 12 units



CUT TIP COTTON MOP

Moist cut tip mop at 300 g and 340 g, suitable for cleaning cold floors for use with stand and wringing bucket. Constituted of 80% cotton and 20% polyester. Suitable for broad areas. Most durability. To be utilized with the 9224 holder.

Color	Reference	Measure	Weight	Code Bars	Packing
● Crude	SP9127P	42x35cm	300g	7898509283603	Box with 12 units
● Crude	SP9128P	42x35cm	340g	7898509283610	Box with 12 units



PLASTIC HOLDER FOR WET MOP

Holder for use with wet mops: SP9110P, SP9111P, SP9127P, SP9128P and SP9113P. Compatible with handles of \varnothing 22 mm and \varnothing 25 mm.

Color	Reference	Measure	Weight	Code Bars	Packing
● Gray	9224	19 x 13cm	88g	7898509280749	Box with 6 units

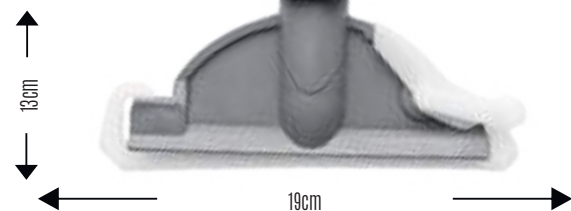

> Mops and Holders

COTTON MINI MOP

Suitable for cleaning small areas. Presents high absorption. To be utilized with the 9230 bucket. Compatible with any threaded handle.

Color	Reference	Measure	Weight	Code Bars	Packing
Gray	9117P	78mm x 61mm x 310mm	190g	7898509280510	Box with 12 units
Yellow	SP9117AM	78mm x 61mm x 310mm	214g	7898509285942	Box with 12 units
Blue	SP9117AZ	78mm x 61mm x 310mm	214g	7898509285911	Box with 12 units
Green	SP9117VD	78mm x 61mm x 310mm	214g	7898509285935	Box with 12 units
Red	SP9117VR	78mm x 61mm x 310mm	214g	7898509285928	Box with 12 units



MICROFIBER STRIPS MINI MOP

Suitable for cleaning small areas. High absorption. Utilized with 9320 bucket. Compatible with any threaded handle.

Color	Reference	Measure	Weight	Code Bars	Packing
Green	SP9119	330mm x 130mm x 80mm	186g	7898509286086	Box with 12 units



SYNTHETIC MINI MOP REFILL

Synthetic Mini Mop Refill.

Color	Reference	Measure	Weight	Code Bars	Packing
Gray	9118	75mm x 320mm	137g	7898509280527	Box with 12 units





PRO MOP W/ DISPENSER

Flat mop with liquid reservoir and spray trigger for more effective cleaning.
600 mL reservoir capacity and 40 cm microfiber mop sold separately as well.

Color	Reference	Measure	Weight	Code Bars	Packing
● Gray	SP9370	130cm x 40cm x 12.5cm	285g	7898509285560	Box with 4 units



MICROFIBER REFILL FOR SP9370 MOP

The microfiber mop refill has been designed to be used with the Mop Dispenser SuperPro (SP9370). Produced in 100% microfiber, it absorbs 7 times more than ordinary cloth. May be machine washed. It is fixed to the mop base with hook and loop. SP9370/1 is suitable for heavy cleaning. SP9370/2 is suitable for cleaning surfaces in general.

Color	Reference	Measure	Weight	Code Bars	Packing
● Blue	SP9370/1	470mm x 127mm x 7mm	47.5g	7898509286505	Box with 6 units
● White	SP9370/2	470mm x 127mm x 7mm	47.5g	7898509286512	Box with 6 units



WAX APPLIYER

Suitable for wax application in floor treatment.
Microfiber refill sold separately (SP9063/1).

Color	Reference	Measure	Weight	Code Bars	Packing
● White	SP9063	370mm x 32mm x 125mm	82.5g	7898509284143	Box with 12 units
● White	SP9063/1	370mm x 60mm x 10mm	20g	7898509287700	Box with 12 units



> Mops and Holders

ALUMINUM FRAME AND MOP ASSEMBLY 40CM

Aluminum base and microfiber mop, ideal for floor waxing.

Color	Reference	Measure	Weight	Code Bars	Packing
 Silver Blue White	SP9129	400mm x 95mm x 45mm	385g	7908057000062	Box with 06 units

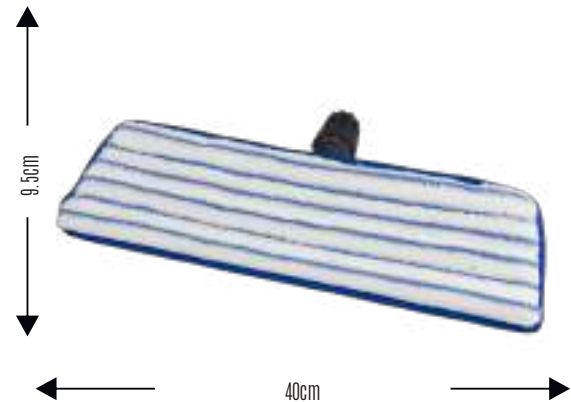

MICROFIBER MOP REFILL 40CM

Refill for SP9129 aluminum frame assembly.

Color	Reference	Measure	Weight	Code Bars	Packing
 White Blue	SP9129R	430mm x 130mm x 5mm	60g	7908057000079	Box with 06 units

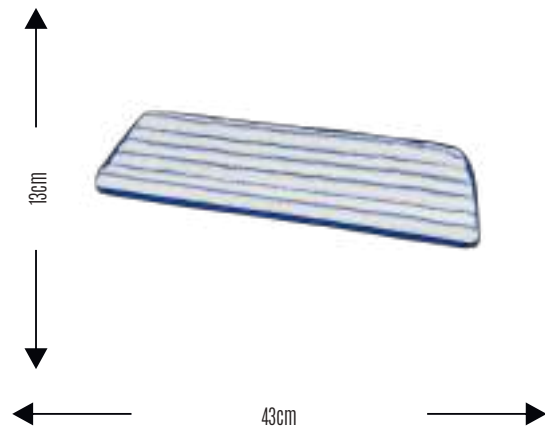

MULTI-PURPOSE MICROFIBER MOP WITH HANDLE

The multipurpose microfiber mop is extremely light and easy to handle due to its aluminum frame. Its handle presents water passage with flow limiting valve, in case the user needs more or less water. It is also possible to apply only with the hand-held plastic base handle. The following items are also sold separately: SP9689/1: PLASTIC BASE FOR MOP; SP9689/2: HOSE CONNECTOR; SP9689R: MICROFIBER MOP REFILL; SP9689C: ALUMINUM HANDLE.

Color	Reference	Measure	Weight	Code Bars	Packing
 Gray	SP9689	270mm x 190mm x 1705mm	455g	7908057000437	Box with 4 units





SP9689 MULTIPURPOSE MICROFIBER MOP PLASTIC BASE

Multipurpose Microfiber Mop Accessory with handle (SP9689).

Color	Reference	Measure	Weight	Code Bars	Packing
● Gray	SP9689/1	270mm x 190mm	175g	7908057000468	1 unit



MULTIPURPOSE MICROFIBER MOP REFILL SP9689

Multipurpose Microfiber Mop Accessory (SP9689).

Color	Reference	Measure	Weight	Code Bars	Packing
● Gray	SP9689R	270mm x 190mm	90g	7908057000444	Box with 4 units



MOP SPONGE BLANKET REFILL

Suitable for cleaning greasy floors or those with a higher degree of dirt. To be utilized with the 9220 holder.

Color	Reference	Measure	Weight	Code Bars	Packing
● Green and Yellow	9211	350mm x 150mm	64g	7898509280695	Box with 12 units

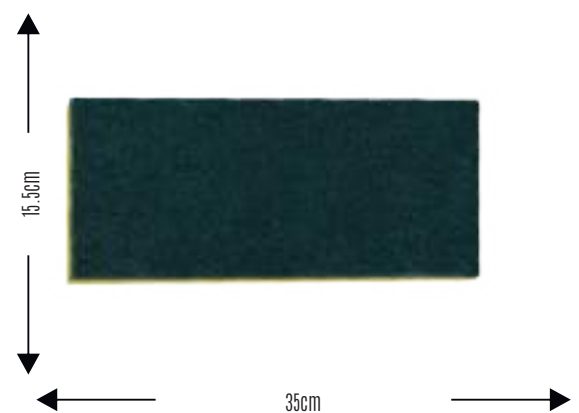



MICROFIBER POWDER MOP 60CM

Suitable for floor maintenance as it polishes and can be used to dust without scratching the wax. Recommended for smooth and dry floors.

Color	Reference	Measure	Weight	Code Bars	Packing
● Blue	SP9114P	650mm x 165mm	232g	7898509283696	Box with 12 units

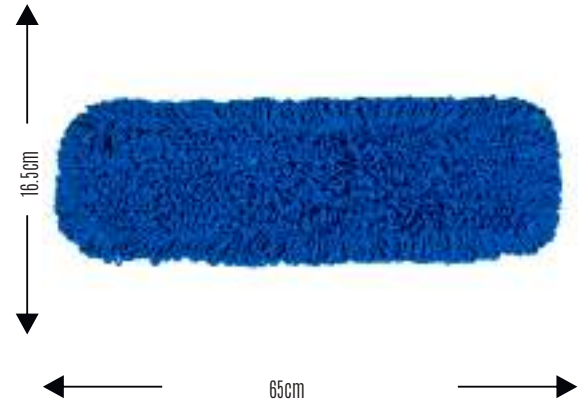

NYLON POWDER MOP 60CM

Suitable for floor maintenance as it polishes and can be used to dust without scratching the wax. Recommended for smooth and dry floors.

Color	Reference	Measure	Weight	Code Bars	Packing
● White	SP9115P	650mm x 165mm	232g	7898509283702	Box with 12 units

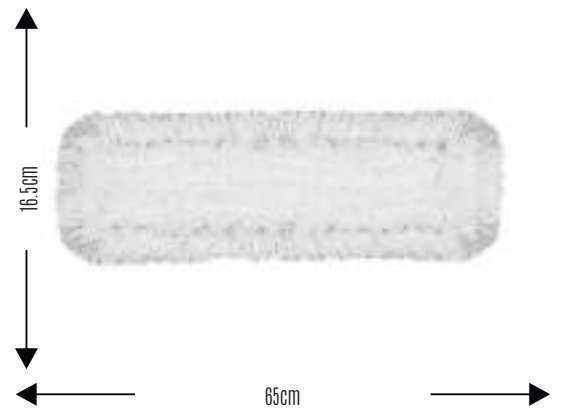

ALUMINUM BASE FOR MOP 60CM

Aluminum bracket for use with SP9114P and SP9115P mops.
Compatible with handles of \varnothing 22mm and \varnothing 25mm.

Color	Reference	Measure	Weight	Code Bars	Packing
● Silver	SP9222	600mm x 120mm x 47mm	427g	7898509284198	Box with 06 units

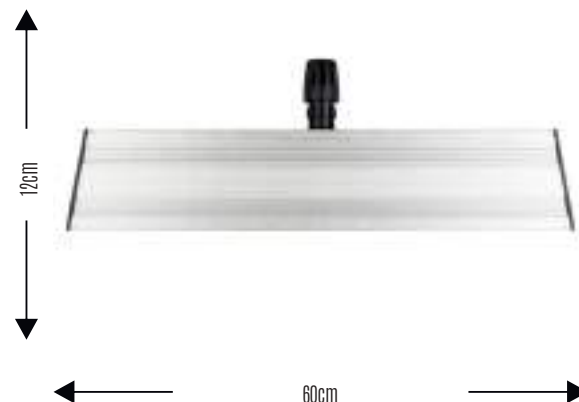



COMPACT MICROFIBER DUSTER

Microfiber duster for general surface cleaning.

Color	Reference	Measure	Weight	Code Bars	Packing
● Gray	SP8801	320mm x 195mm x 50mm	70g	7898509288837	Box with 10 units



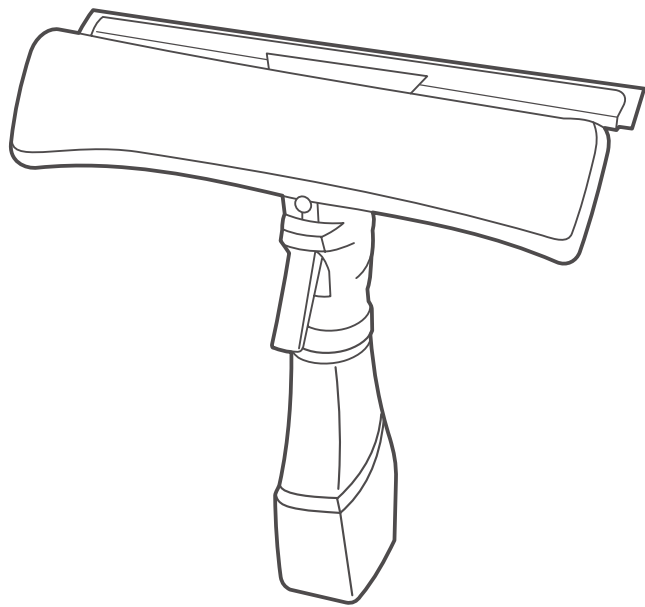

Squeegees

SIMPLE RUBBER ALUMINUM SQUEEGEE

Aluminum body. Reinforced polypropylene base. 01 flexible synthetic rubber blade Cartridge sold separately. Compatible with any threaded handle.

Color	Reference	Measure	Weight	Code Bars	Packing
● Gray	9050	500mm x 35mm x 105mm	250g	7898509280336	Box with 6 units
● Gray	9057	700mm x 35mm x 105mm	305g	7898509280411	Box with 6 units



DOUBLE RUBBER ALUMINUM SQUEEGEE

Aluminum body. Reinforced polypropylene base. 02 blades of flexible synthetic rubber. Cartridges sold separately. Compatible with any threaded handle.

Color	Reference	Measure	Weight	Code Bars	Packing
● Gray	9056	500mm x 80mm x 105mm	368g	7898509280404	Box with 6 units
● Gray	9058	700mm x 80mm x 105mm	495g	7898509280428	Box with 6 units



Produced to meet small to large environments, the institutional squeegee lines offer different sizes in different materials, serving each type of customer in the best way.



ALUMINUM SQUEEGEE RUBBER REFILL

Rubber seals for 50 cm and 70 cm aluminum squeegees.
Compatible with aluminum squeegees.

Color	Reference	Measure	Weight	Code Bars	Packing
● Black	90502	700 mm x 32 mm	70g	7898509280343	Box with 36 units
● Black	90503	500 mm x 32 mm	51g	7898509280350	Box with 36 units



DOUBLE PUSH PLASTIC SQUEEGEE WITH HANDLE

Push squeegees combine flexibility and strength. May be used on various floors. Special fitting that ensures that the cloth does not come off during cleaning. Polypropylene squeegee with double EVA rubber. 1.40 cm handles included. Compatible with any threaded handle.

Color	Reference	Measure	Weight	Code Bars	Packing
● Gray	9154	500mm x 35Mm x 70mm	425g	7898509280657	Box with 15 units
● Gray	9054C	450mm x 35Mm x 70mm	350g	7898509280398	Box with 15 units
● Gray	9053C	300mm x 35Mm x 70mm	324g	7898509280381	Box with 15 units



> Squeegees

SIMPLE PLASTIC SQUEEGEE WITH HANDLE

Rubber profile ensures greater squeegee resistance. Its thickness helps in heavier jobs. Claws that help attach the cloth to the squeegees. Injected profile of synthetic simple rubber. Polypropylene squeegee that comes with 1.20cm handles. Compatible with any threaded handle.

Color	Reference	Measure	Weight	Code Bars	Packing
● Green	9152	500mm x 35mm x 70mm	146g	7898509280640	Box with 12 units
● Green	9052C	400mm x 35mm x 70mm	351g	7898509280374	Box with 12 units
● Green	9051C	300mm x 35mm x 70mm	305g	7898509280367	Box with 12 units



EVA PLASTIC SQUEEGEE WITH BRUSH

Professional plastic squeegee that has been developed to become a product that brings maximum efficiency in floor drying. In addition to having the brush part for cleaning the dirtiest floor. Compatible with any threaded handle.

Color	Reference	Measure	Weight	Code Bars	Packing
● Gray	SP9050CZ	480mm x 65mm x 75mm	165g	7908057000383	Box with 6 units





PROFESSIONAL PLASTIC SQUEEGEE 45cm

Professional plastic squeegee that has been developed to become a product that brings maximum efficiency in floor drying. The barrier structure blocks the flow of water that may overlap the product. Compatible with handles of \varnothing 22 mm and \varnothing 25 mm.

Color	Reference	Measure	Weight	Code Bars	Packing
● Gray	SP9157	450mm x 100mm x 130mm	240g	7908057000734	Box with 12 units
● Blue	SP9157AZ	450mm x 100mm x 130mm	240g	7908057000833	Box with 12 units

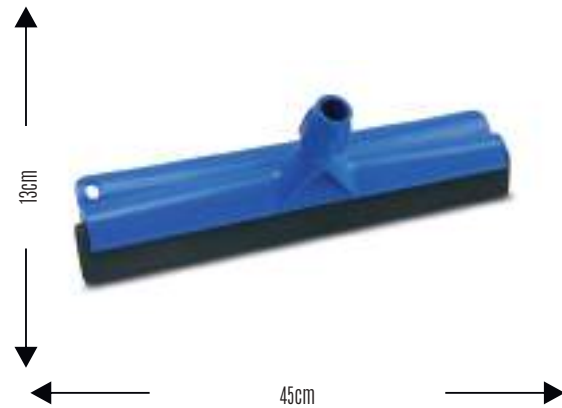

PROFESSIONAL PLASTIC SQUEEGEE 65cm

Professional plastic squeegee that has been developed to become a product that brings maximum efficiency in floor drying. The barrier structure blocks the flow of water that may overlap the product. Compatible with handles of \varnothing 22 mm and \varnothing 25 mm.

Color	Reference	Measure	Weight	Code Bars	Packing
● Gray	SP9158	650mm x 100mm x 130mm	284g	7908057000741	Box with 6 units
● Blue	SP9158AZ	650mm x 100mm x 130mm	284g	7908057000840	Box with 6 units



> Squeegees

GLASS CLEANING SQUEEGEE SET

Contains: Rubber squeegee 30 cm; Microfiber squeegee 37 cm;
Extended handle up to 1.20m; Microfiber refill: 37 cm.

Color	Reference	Measure	Weight	Code Bars	Packing
● Gray	SP9059	580mm x 245mm	466g	7898509284044	Box with 12 units



COMBINED PLASTIC SQUEEGEE FOR GLASS

Equipment consisting of refill and squeegee for cleaning glass, mainly used in stations, glazed areas or at high heights. They make the cleaning process easier and save time on tasks. Compatible with any tapered bushing squeegee (SP9012B).

Color	Reference	Measure	Weight	Code Bars	Packing
● Gray	SP9061	350mm x 95mm x 180mm	230g	7898509284082	Box with 6 units
● Gray	SP9066	450mm x 95mm x 180mm	295g	7898509284167	Box with 6 units



COMBINED SQUEEGEE MICROFIBER REFILL

Microfiber glass cleaning cartridge for use with SP9066 window cleaner. The washer fabric allows high absorption of liquids without splashing, ensuring longer cleaning. Composition: 100% microfiber

Color	Reference	Measure	Weight	Code Bars	Packing
● White	SP9064/1	350mm x 75mm x 30mm	35g	7908057000215	Box with 6 units
● White	SP9066/1	450mm x 75mm x 30mm	45g	7908057000222	Box with 6 units





WASH AND DRY PLASTIC COMBINED SQUEEGEE

Used for glass washing and drying. Rubber and microfiber squeegee.
Steel sheet handle up to 1.20 m.

Color	Reference	Measure	Weight	Code Bars	Packing
● Gray	SP9065	330mm x 130mm x 155mm	352g	7898509284051	Box with 12 units

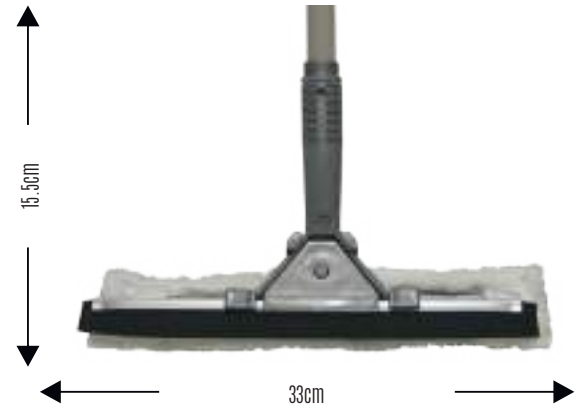

WASH AND DRY PLASTIC COMBINED SQUEEGEE

Synthetic rubber squeegee. Microfiber refill. Handle not included.
Compatible with any tapered bushing (SP9012B).

Color	Reference	Measure	Weight	Code Bars	Packing
● Gray	SP9067	375mm x 70mm x 160mm	180g	7898509286635	Box with 12 units

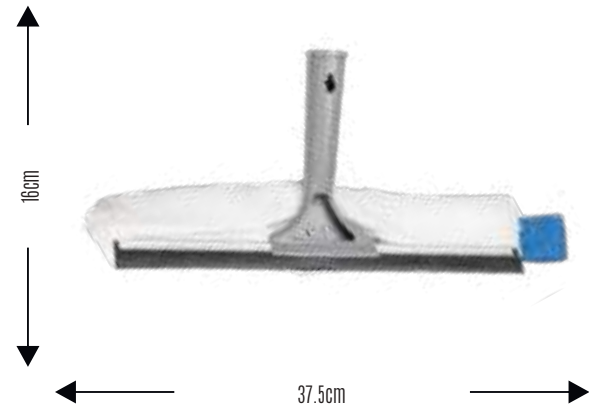

COMBINED SQUEEGEE MICROFIBER REFILL

Squeegee refill SP9067. Composition: 100% microfiber

Color	Reference	Measure	Weight	Code Bars	Packing
● White	SP9067/1	365mm x 75mm x 20mm	47g	7898509286642	Box with 12 units

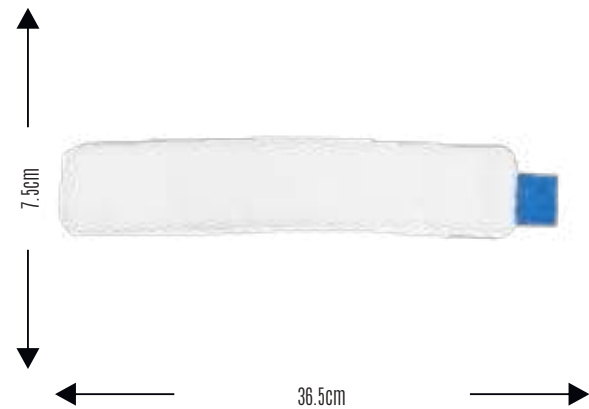

> Squeegees

COMBINED SQUEEGEE MICROFIBER REFILL

Squeegee refill SP9067. Composition: synthetic material.

Color	Reference	Measure	Weight	Code Bars	Packing
● Yellow	SP9067/2	365mm x 75mm x 20mm	47g	7898509286659	Box with 12 units

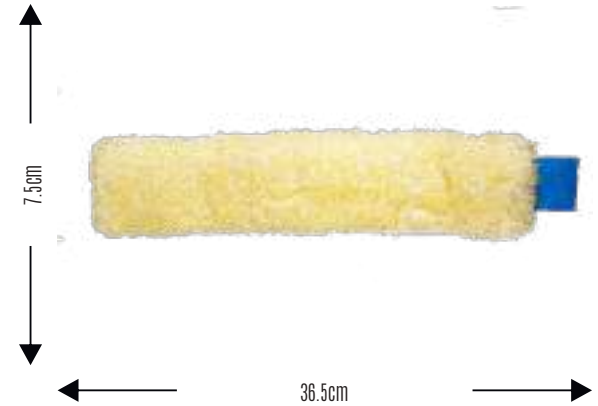

GLASS CLEANING PLASTIC SQUEEGEE W/ DISPENSER

Glass cleaning squeegee with 250 mL reservoir for cleaning.
Refill also sold separately (SP9069R).

Color	Reference	Measure	Weight	Code Bars	Packing
● Gray	SP9069	260mm x 95mm x 268mm	190g	7898509286680	Box with 12 units



MICROFIBER WIPER REFILL

SP9069 squeegee microfiber refill.

Color	Reference	Measure	Weight	Code Bars	Packing
● Crude	SP9069R	250mm x 60mm x 10mm	30g	7898509286697	Box with 12 units





DOUBLE SLIM PLASTIC SQUEEGEE 40cm

40 cm double EVA rubber squeegee.
1.20 m handle included

Color	Reference	Measure	Weight	Code Bars	Packing
● Gray	SP9151C	40cm	352g	7898509289346	Box with 12 units



FOAM AND SPRAY PLASTIC SQUEEGEE

Squeegee wiper with reservoir.

Color	Reference	Measure	Weight	Code Bars	Packing
● White and Gray	9272	330mm x 200mm x 70mm	120g	7898509281739	Box with 12 units



SQUEEGEE PLASTIC SPONGE

Clean glass squeegee. The side with the yellow sponge allows for applying the product to the surface to be cleaned. The side with the rubber removes the liquid. Compatible with any tapered bushing handle (SP9012B).

Color	Reference	Measure	Weight	Code Bars	Packing
● Gray	9279	215mm x 205mm x 70mm	91g	7898509281746	Box with 12 units



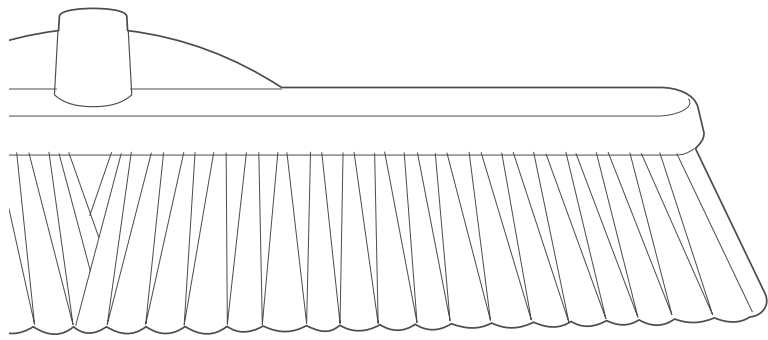

Brooms

STREET CLEANER BROOMSTICK WITH RIGID BRISTLE

With extra-long and robust bristles, it is ideal for heavy cleaning of debris and construction debris, allowing for sweeping outdoor areas in large volume. Compatible with any threaded handle.

Color	Reference	Measure	Weight	Code Bars	Packing
● Black	9007	300mm x 90.6 x 180mm	635g	7898509280190	Box with 12 units



SYNTHETIC FUR BRISTLE BALL BROOM

Broom consisting of natural fur and PET. No plumage. Indicated for floors with gloss (wax treatment, porcelain and treated wood floors). Efficient against dust, does not scratch baseboards or walls due to the side bristles. 1.20m handle included.

Color	Reference	Measure	Weight	Code Bars	Packing
● Black	9684	320mm x 15mm x 90 mm	582g	7898509281388	Box with 8 units



Our line of brooms has a wide variety of models for different uses. They are soft, rigid, reinforced, and also of varying sizes and angles specially developed to facilitate the tasks associated with cleaning different environments and floors.

SuperPro
* BETANIN



PRO BROOM HOUSEHOLD AND STREET

With firm bristles, it has been developed for outdoor areas in cleaning cold floors, carpets and rugs. 1.40 m handle included.

Color	Reference	Measure	Weight	Code Bars	Packing
● Gray	9001C	290mm x 65mm x 190mm	195g	7898509280145	Box with 15 units



VARRY 1000 BROOM

Soft bristles. No plumage. Suitable for space-limited locations and smooth floors with fine or light dirt. 1.20m handle included.

Color	Reference	Measure	Weight	Code Bars	Packing
● Black	9003C	300mm x 75mm x 110mm	245g	7898509280152	Box with 12 units





> Brooms

STRAIGHT BROOM 40cm

Soft-bristled broom without plumage. Suitable for sweeping places with larger free areas and floors with thin or light dirt (indoor areas). Does not include handle. Compatible with any threaded handle.

Color	Reference	Measure	Weight	Code Bars	Packing
● Black	9004D	400mm x 25mm x 120mm	427g	7898509280169	Box with 12 units



RIGID BROOM 40cm

Broom with greater coverage area, rigid bristles without plumage, indicated for sweeping large to medium sized dirt on rough and uneven floors. Suitable for outdoor areas. Compatible with any threaded handle.

Color	Reference	Measure	Weight	Code Bars	Packing
● Gray	9005D	400mm x 25mm x 120mm	441g	7898509280176	Box with 12 units



RIGID PLASTIC BROOM

Rigid bristles suitable for removal of encrusted dirt on the floor. The short bristles are very rigid, operating very well to remove sludge, wax debris (with help of remover), fats and other dirt. 1.20m handle included.

Color	Reference	Measure	Weight	Code Bars	Packing
● Green	9006C	250mm x 55mm x 60mm	430g	7898509280183	Box with 12 units

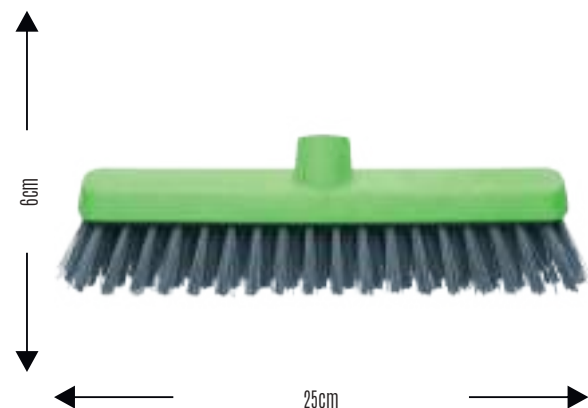



ANGULAR PLASTIC BROOM

Its long, firm bristles with angular inlay remove light dirt in hard-to-reach locations. With plumage. Suitable for indoor areas. 1.20 m handle included.

Color	Reference	Measure	Weight	Code Bars	Packing
● Gray	9008C	250mm x 220mm x 40mm	398g	7898509280206	Box with 12 units



SUPER TUPY BROOM

Long, firm bristles with angular inlay. With plumage. Suitable for cleaning corners. 1.20m handle included.

Color	Reference	Measure	Weight	Code Bars	Packing
● Gray	9021C	330mm x 300mm x 45mm	558g	7898509280299	Box with 12 units



RIGID BRISTLE BROOM 60cm

Broom with large coverage of swept areas and higher productivity. Suitable for medium to large dirt brooming, on rough and uneven floors. Compatible with any threaded handle.

Color	Reference	Measure	Weight	Code Bars	Packing
● Black	9063D	600mm x 70mm x 160mm	441g	7898509282965	Box with 12 units



> Brooms

SOFT BRISTLE BROOM 60cm

Soft-bristled broom without plumage.
Suitable for sweeping places with larger free areas and floors with thin or light dirt (indoor areas). Compatible with any threaded handle.

Color	Reference	Measure	Weight	Code Bars	Packing
● Black	9064D	600mm x 70mm x 160mm	716g	7898509282972	Box with 12 units



MULTIPURPOSE BROOM

Bristling with plumage. Suitable for out and indoor areas.
Color coding. 1.40m handle included, ergonomically correct.
This model can also be sold handleless in box with 12 units
(SP9671AM/SP9671AZ/SP9671VD/SP9671VR)

Color	Reference	Measure	Weight	Code Bars	Packing
● Yellow	9672C	300mm x 180mm x 45.6mm	450g	7898509281340	Box with 15 units
● Blue	9673C	300mm x 180mm x 45.6mm	450g	7898509281357	Box with 15 units
● Red	9674C	300mm x 180mm x 45.6mm	450g	7898509281364	Box with 15 units
● Green	9675C	300mm x 180mm x 45.6mm	450g	7898509281371	Box with 15 units





SuperPro

 **BETTANIN**





SUPERPRO PICKUP DUSTPAN

Articulated collecting dustpan without flexible blade. Suitable for high traffic locations. 0.90 m handle included.

Color	Reference	Measure	Weight	Code Bars	Packing
● Gray	9260	26cm x 26cm x 12cm	633g	7898509280855	Box with 12 units



JEITOSA SHOVEL

Injected rubber that does not separate from the body of the pans. Adheres to the surface, preventing dirt from passing under the shovel. Avoids contact with dirt. 0.90 m handle included.

Color	Reference	Measure	Weight	Code Bars	Packing
● Gray	9253C	26cm x 25cm x 8.5cm	291g	7898509280824	Box with 12 units



With different collection systems, SuperPro paddles make it easy to collect materials in general hygienically and safely. Ergonomic, they allow for better posture of the operator, increasing productivity and decreasing physical wear.

SuperPro
* BETANIN



PLASTIC PAN

Suitable for manual use.

Color	Reference	Measure	Weight	Code Bars	Packing
● Gray	9255D	315mm x 230mm	126g	7898509280848	Box with 12 units



LARGE PLASTIC COLLECTOR SHOVEL

Articulated collector shovel with flexible TPR rubber blade for better removal of dirt. It has the same width as a multipurpose broom. Suitable for high traffic locations. 0.90m handle included.

Color	Reference	Measure	Weight	Code Bars	Packing
● Gray	SP9261C	340mm x 325mm x 140mm	621g	7898509289599	Box with 10 units



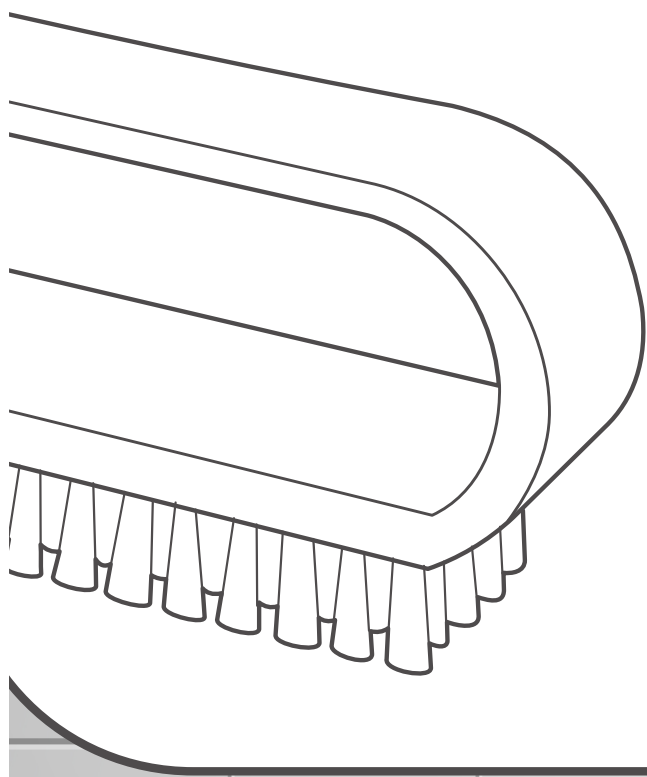

Brushes

PLASTIC BRUSH FOR TILES AND CORNERS

Suitable for cleaning tiles and corners. The shape of its bristles have been developed to remove various types of dirt.

Color	Reference	Measure	Weight	Code Bars	Packing
● Gray	9139	500mm x 24mm x 50mm	35g	7898509280565	Box with 12 units

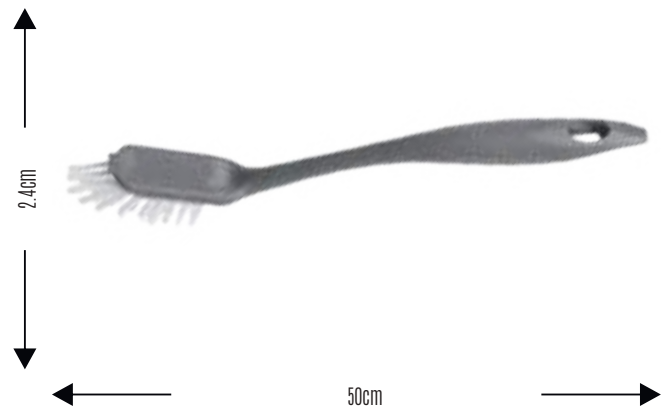

FRAMELESS SANITARY BRUSH

Suitable for cleaning toilets, removes dirt more easily and efficiently.

Color	Reference	Measure	Weight	Code Bars	Packing
● White	9140	340mm x Ø 75mm	89g	7898509280572	Box with 36 units

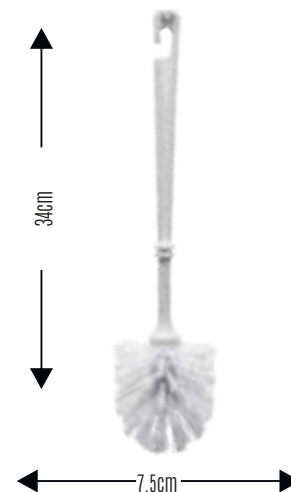

Sturdy and ergonomic, SuperPro brushes assist in heavier and more difficult cleaning. They are efficient in irregular or rustic finishing places, corners, delicate surfaces or with a high degree of dirt, besides assisting in cleaning toilets and work equipment. They have high potential of removal and resistance to chemicals.

SuperPro
* BETANIN



VASSOURITA BRUSH

Suitable for cleaning toilets.

Color	Reference	Measure	Weight	Code Bars	Packing
● Gray	9141	330mm x Ø 45mm	77g	7898509280589	Box with 12 units

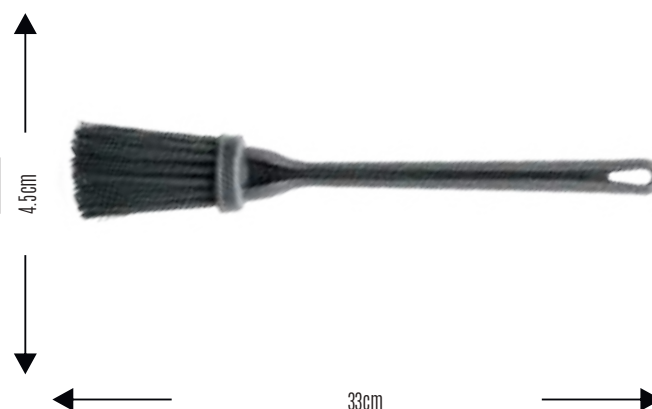

VARREMESA BRUSH

With soft bristles, it is suitable for cleaning various types of surfaces.

Color	Reference	Measure	Weight	Code Bars	Packing
● Gray	9142	253mm x 42mm x 110mm	90g	7898509280596	Box with 6 units



> Brushes

SANITARY BRUSH WITH HOLDER

Suitable for cleaning toilets, removes dirt more easily and efficiently.
Comes with holder to store the brush.

Color	Reference	Measure	Weight	Code Bars	Packing
● White	9143	345mm x Ø 125mm	125g	7898509280602	Box with 12 units

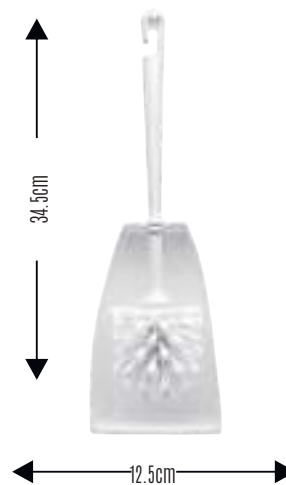

SCRUB BRUSH

Its manual holder provides greater comfort in performing tasks.

Color	Reference	Measure	Weight	Code Bars	Packing
● Gray	9144	146.2mm x 60mm x 87mm	98.5g	7898509280619	Box with 12 units



PLASTIC SANITARY BRUSH PETALS

Suitable for cleaning toilets, removes dirt more easily and efficiently.
Comes with holder to store the brush.

Color	Reference	Measure	Weight	Code Bars	Packing
● White	9146	375mm x Ø 142mm	285g	7898509280633	Box with 12 units





OVAL MULTI-PURPOSE PLASTIC BRUSH

Our oval multipurpose brush is sturdy and durable, suitable for scrubbing clothes and also for washing various types of surfaces, in light as well as heavy cleaning.

Color	Reference	Measure	Weight	Code Bars	Packing
● Gray	9137T	120mm x 65mm x 55mm	87.5g	7898509280541	Box with 36 units



PLASTIC BRUSH GENERAL USE

General purpose brush, suitable for cleaning various types of surfaces, cleaning the most difficult corners. Its bristles allow for the removal of dirt. It is also indicated for hand hygiene.

Color	Reference	Measure	Weight	Code Bars	Packing
● Gray	9138T	95mm x 45mm x 25mm	20g	7898509280558	Box with 36 units



BLUE LONG HANDLE MULTIPLE BRUSH

Durable and sturdy, its handle allows for reaching the toughest spots. Suitable for cleaning boots.

Color	Reference	Measure	Weight	Code Bars	Packing
● Blue	SP9145AZ	510mm x 78mm x 75mm	295g	7898509283627	Box with 12 units



> Brushes

SUPERPRO RED BRUSH

Durable and sturdy, its handle allows for reaching the longest distances. Even more rigid bristles.

Color	Reference	Measure	Weight	Code Bars	Packing
● Red	SP9149	352mm x 70mm x 60mm	115.8g	7898509283726	Box with 12 units



MULTIPURPOSE PRO BRUSH

Multipurpose Pro Brush has been designed for removing dirt from various types of surfaces. With the most resistant bristles, they help in the cleaning of kitchen utensils.

Color	Reference	Measure	Weight	Code Bars	Packing
● Gray	SP9150	270mm x 64mm x 53mm	42g	7898509286673	Box with 12 units

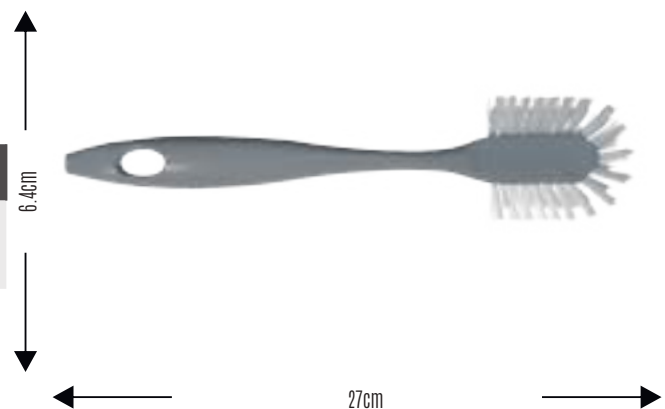

CAR WASH BRUSH BALL

With soft and feathered bristles, it has three water distribution channels that, with the aid of the cable with water passage, facilitate cleaning. Compatible with the SP9037 handle.

Color	Reference	Measure	Weight	Code Bars	Packing
● Yellow	SP9687	280mm x 150mm x 120mm	610g	7898509286048	Box with 6 units





CAR WASH BRUSH BALL WITH RESERVOIR

Brush with reservoir for chemicals such as detergents and cleaners.
The reservoir has chemical flow regulation.
Its bristles are feathered and do not scratch the surface.
It should be used with the water pass handle (SP9038).

Color	Reference	Measure	Weight	Code Bars	Packing
● Gray	SP9688	300mm x 140mm x 160mm	740g	7898509286055	Box with 6 units



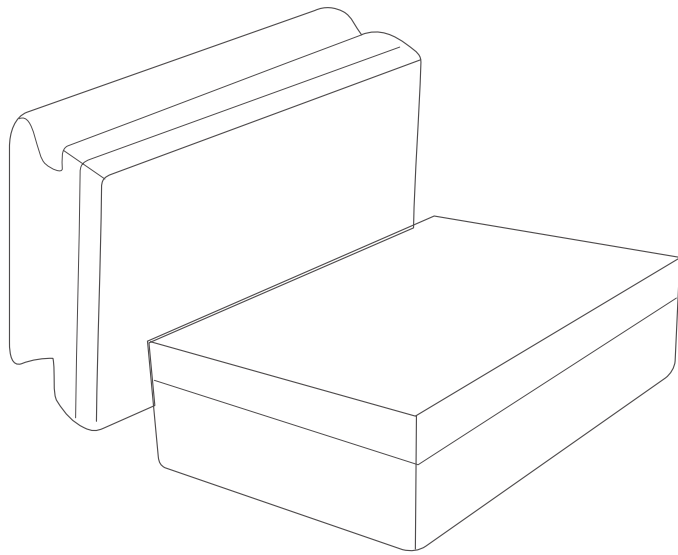

Sponges

DOUBLE FACE SPONGE

Sponge with silver ions, which inhibits the proliferation of bacteria in the sponge body. Film without printing. Individually packaged in packs of 10 units

Color	Reference	Measure	Weight	Code Bars	Packing
 Yellow and Green	9401	110mm x 75mm x 23mm	7.5g	7898509280893	Package with 10 units

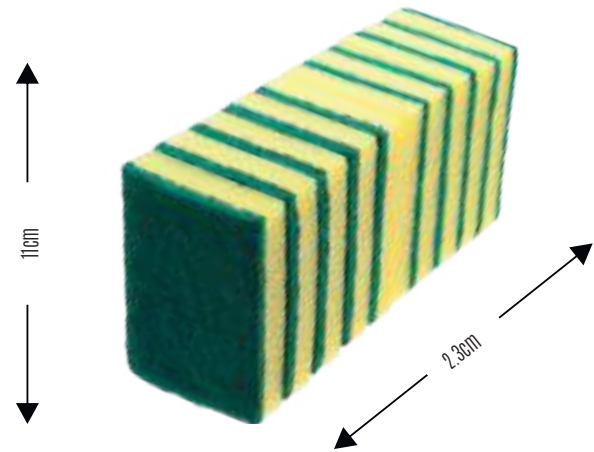

DOUBLE SPONGE NAIL PROTECT

Hand and nail protection at the moment of use.

Color	Reference	Measure	Weight	Code Bars	Packing
 Yellow and Green	9404	100mm x 75mm x 42mm	10.5g	7898509280923	Box with 100 units

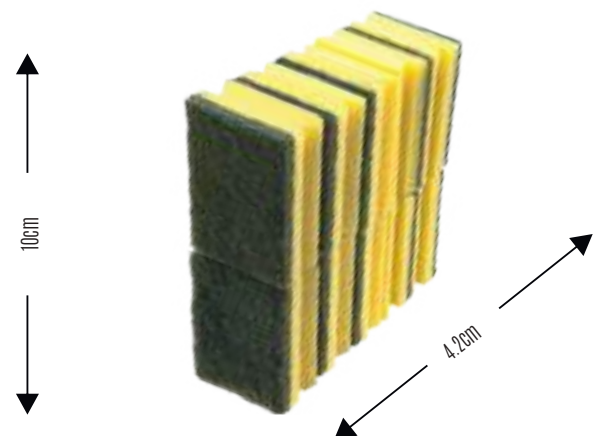

Different abrasives help with everything from removing tough dirt to cleaning dishes and glazes without scratching.

The line offers differentiated measures to serve the industrial and gastronomic sectors in specific lines.



DOUBLE FACE BIG SPONGE

Product with silver ion technology eliminating 99.9% of the bacteria in the sponge body. Sold in packs of 10 units

Color	Reference	Measure	Weight	Code Bars	Packing
Yellow and Green	9405	180mm x 100mm x 23mm	19.3g	7898509280930	Box with 100 units

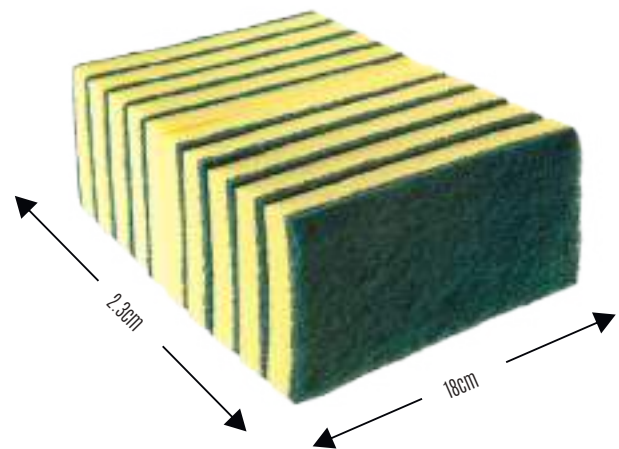

DOUBLE FACE ECONOMIC SPONGE

Product with silver ion technology eliminating 99.9% of the bacteria in the sponge body. Sold in boxes of 240 individually packed pieces.

Color	Reference	Measure	Weight	Code Bars	Packing
Yellow and Green	9410	110mm x 75mm x 23mm	11g	7898509280985	Box with 240 units



> Sponges

DOUBLE FACE SPONGE

Product with silver ion technology eliminating 99.9% of the bacteria in the sponge body. Sold in packages of 120 individually packed pieces.

Color	Reference	Measure	Weight	Code Bars	Packing
Yellow and Green	94106	110mm x 75mm x 23mm	7.5g	7898509280992	Box with 120 units



DOUBLE SIDED SPONGE WITHOUT FILM

Product with silver ion technology eliminating 99.9% of the bacteria in the sponge body. Sold in packages of 240 units, no film.

Color	Reference	Measure	Weight	Code Bars	Packing
Yellow and Green	9410SP	110mm x 75mm x 23mm	9g	7898509281005	Box with 240 units

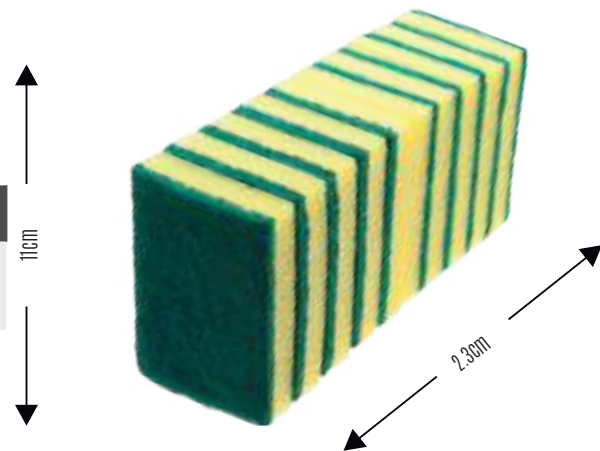

HIGH PERFORMANCE MULTI-PURPOSE SPONGE

Product with silver ion technology eliminating 99.9% of the bacteria in the sponge body. Packages with 3 units each.

Color	Reference	Measure	Weight	Code Bars	Packing
Yellow and Green	9423	110mm x 75mm x 23mm	7.5g	7898509283382	Box with 80 units





DOUBLE FACE MULTIPURPOSE PLUS SPONGE

Suitable for general cleaning. The green part of the sponge is designed for heavier cleaning and the yellow part, for lighter cleaning. Individually packaged in packs of 10 units

Color	Reference	Measure	Weight	Code Bars	Packing
Yellow and Green	9406F	100mm x 71mm x 21mm	6.7g	7898509280947	Box with 120 units

10cm



DOUBLE FACE PLUS SPONGE

Suitable for general cleaning. The green portion of the sponge is designed for heavier cleaning and the yellow portion, for lighter cleaning. Packages with 10 pieces. Not individually packaged.

Color	Reference	Measure	Weight	Code Bars	Packing
Yellow and Green	9406P	100mm x 71mm x 21mm	6.7g	7898509280954	Box with 120 units

10cm



MULTI-PURPOSE FILM-FREE SPONGE

Suitable for general cleaning.
Sold in boxes of 240 non wrapped pieces.

Color	Reference	Measure	Weight	Code Bars	Packing
Yellow and Green	SP9471SP	100mm x 71mm x 20mm	6g	7898509286727	Box with 240 units

10cm

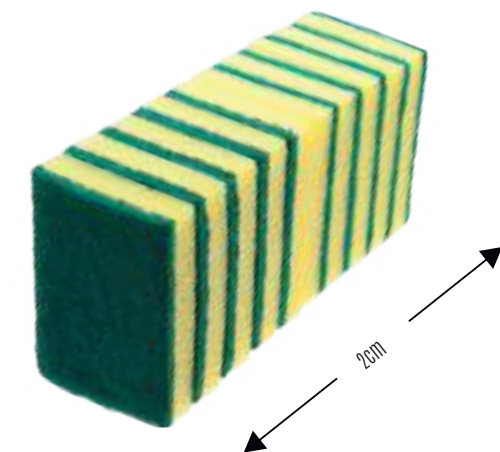

> Sponges

DOUBLE FACE SFREG SPONGE

Presents two faces, indicated for delicate cleanings, such as crystal glasses, crockery and porcelain.

Color	Reference	Measure	Weight	Code Bars	Packing
 Yellow and Red	9407	150mm x 100mm x 34mm	11.5g	7898509280961	Box with 100 units

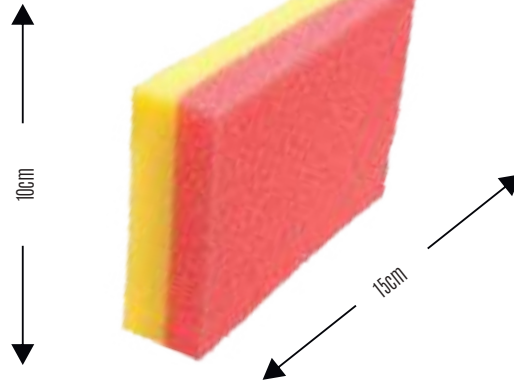

GRILL SPONGE

Removes all dirt and grease impregnated on barbecues, grills, skewers, ovens, iron pans and plates.

Color	Reference	Measure	Weight	Code Bars	Packing
 Gray	9499	110mm x 75mm x 35mm	16.6g	7898509283092	Box with 60 units

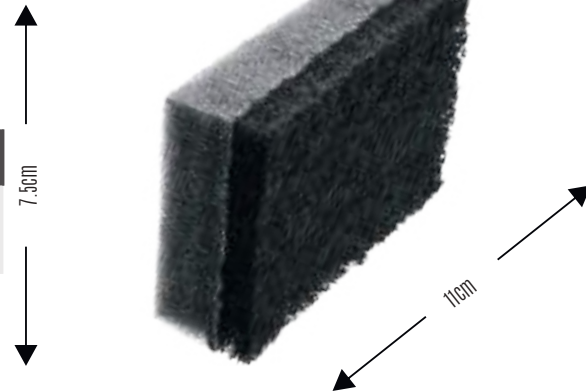

DOUBLE FACE BIG SPONGE

Ideal for removing difficult dirt on various surface types.

Color	Reference	Measure	Weight	Code Bars	Packing
 Yellow and Green	9414	245mm x 90mm x 23mm	22g	7898509281029	Box with 100 units

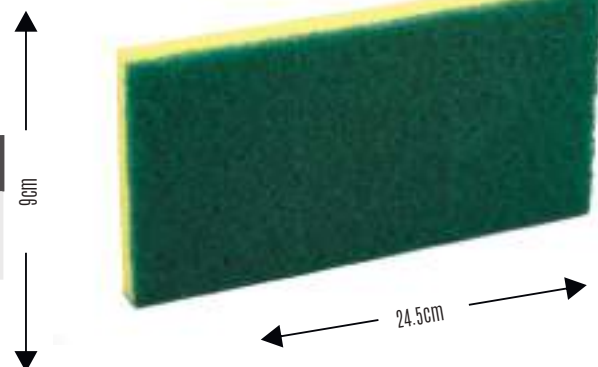



ABRASIVE SPONGE

Ideal for removing difficult dirt on various surface types.

Color	Reference	Measure	Weight	Code Bars	Packing
 Yellow and Green	9417	300mm x 75mm x 23mm	21.3g	7898509281043	Box with 100 units

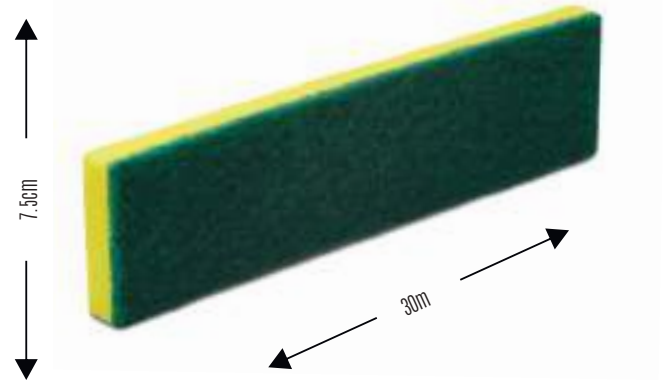

TEFLON BLUE BLANKET SPONGE

Sponge suitable for cleaning teflon utensils.

Color	Reference	Measure	Weight	Code Bars	Packing
 Blue	9418	110mm x 75mm x 25mm	8.6g	7898509284372	Box with 100 units

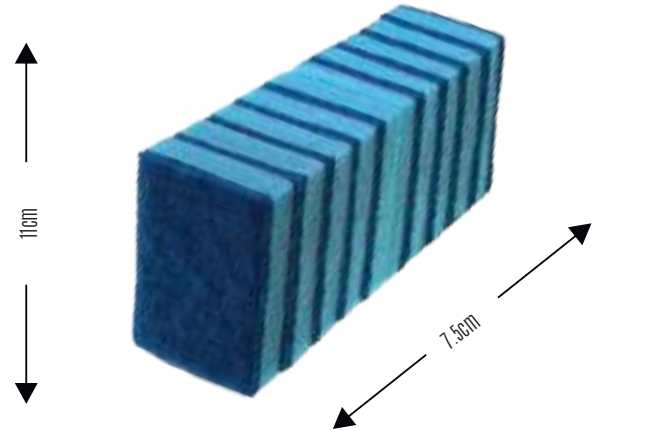

CAR WASH SPONGE

Sponge suitable for car wash.

Color	Reference	Measure	Weight	Code Bars	Packing
 Gray	9422	200mm x 130mm x 70mm	27.9g	7898509283139	Box with 24 units

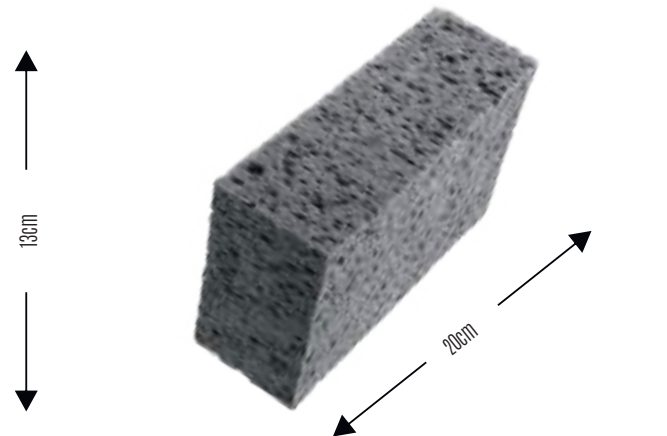

> Sponges

REPLACEMENT SPONGE

Ideal for removing difficult dirt on various surface types.

Color	Reference	Measure	Weight	Code Bars	Packing
Yellow and Green	SP9440	400mm x 75mm x 23mm	40g	7898509286369	Box with 120 units

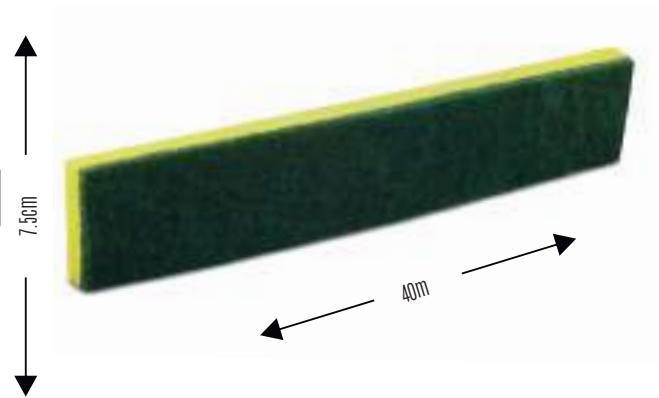

DOUBLE FACE SOFT SPONGE

Indicated for light cleaning in toilets, shower stalls, glass, crystals, stainless steel surfaces, etc. Individually packaged, packs of 10 units

Color	Reference	Measure	Weight	Code Bars	Packing
White and Pink	9403	110mm x 75mm x 23mm	8g	7898509280916	Box with 100 units

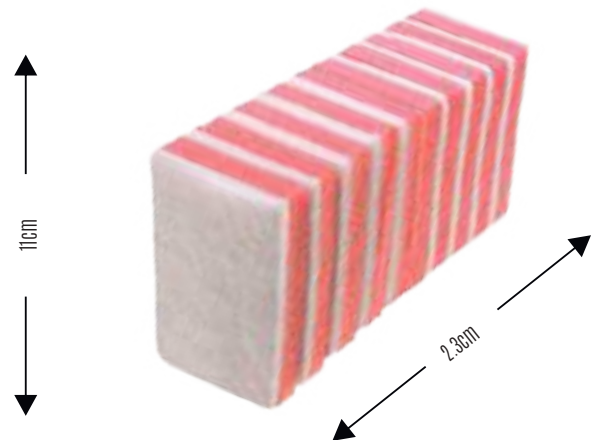

SOFT SPONGE

It is non-abrasive. Suitable for hospital environments. Suitable for delicate surfaces. Individually packaged.

Color	Reference	Measure	Weight	Code Bars	Packing
Yellow	9399	110mm x 75mm x 32mm	4.2g	7898509280886	Box with 240 units





SuperPro
* **BETTANIN**

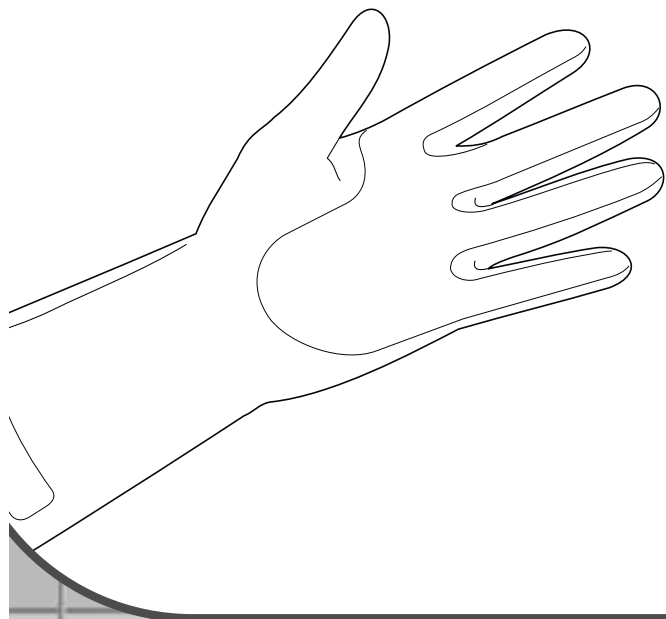

Gloves

STANDARD QUALITY LATEX MULTI-PURPOSE GLOVES

Made of high quality natural latex with non-slip palm and fingers and cotton-lined interior.
Handle with ferrule finish.

Available in yellow, blue and orange colors.



Color	Reference	Measure	Weight	Code Bars	Packing
Yellow	13000/4G	300mm x 115mm	50g	7898509283283	Box with 48 units
Yellow	13000/4M	300mm x 115mm	45.8g	7898509283290	Box with 48 units
Yellow	13000/4P	300mm x 115mm	41.6g	7898509283306	Box with 48 units
Blue	13000AZ/4G	300mm x 115mm	50g	7898509289643	Box with 48 units
Blue	13000AZ/4M	300mm x 115mm	45.8g	7898509289636	Box with 48 units
Blue	13000AZ/4P	300mm x 115mm	41.6g	7898509289629	Box with 48 units
Orange	13000LR/4G	300mm x 115mm	50g	7908057000185	Box with 48 units
Orange	13000LR/4M	300mm x 115mm	45.8g	7908057000178	Box with 48 units
Orange	13000LR/4P	300mm x 115mm	41.6g	7908057000161	Box with 48 units

For different purposes, SuperPro gloves have specific features that guarantee the comfort and protection the user needs while handling equipment, sanitizing and chemical products.



SILVER VARNISH LATEX GLOVE

Made of additive natural latex, waterproofed with silver varnish and anti-allergic reducing agent. Fingers and palm with non-slip texture. Wrist with ferrule finish. Available in yellow and blue colors.

Color	Reference	Measure	Weight	Code Bars	Packing
Yellow	13001/4G	300mm x 115mm	62.8g	7898509283313	Box with 48 units
Yellow	13001/4M	300mm x 115mm	60g	7898509283320	Box with 48 units
Yellow	13001/4P	300mm x 115mm	57.8g	7898509283337	Box with 48 units
Blue	13001AZ/4G	300mm x 115mm	62.8g	7898509289674	Box with 48 units
Blue	13001AZ/4M	300mm x 115mm	60g	7898509289667	Box with 48 units
Blue	13001AZ/4P	300mm x 115mm	57.8g	7898509289650	Box with 48 units



STANDARD QUALITY NITRILE GLOVE

Made of green nitrile rubber with lining. Fingers and palm with non-slip texture. Wrist with straight finish.

Color	Reference	Measure	Weight	Code Bars	Packing
Green	13002/4G	300mm x 115mm	54.9g	7898509283344	Box with 48 units
Green	13002/4M	300mm x 115mm	52g	7898509283351	Box with 48 units
Green	13002/4P	300mm x 115mm	50g	7898509283368	Box with 48 units



> Gloves

POWDER FREE DISPOSABLE VINYL GLOVE

Suitable for general use protecting the user in light and medium jobs.
Not recommended for clinical or hospital use.

Color	Reference	Measure	Weight	Code Bars	Packing
Clear	13006/G	215mm x 120mm x 60mm	540g	7908057000505	Box of 10 boxes with 100 pieces.
Clear	13006/M	215mm x 120mm x 60mm	475g	7908057000499	Box of 10 boxes with 100 pieces.
Clear	13006/P	215mm x 120mm x 60mm	455g	7908057000482	Box of 10 boxes with 100 pieces.
Blue	13006AZ/G	215mm x 120mm x 60mm	540g	7908057000536	Box of 10 boxes with 100 pieces.
Blue	13006AZ/M	215mm x 120mm x 60mm	475g	7908057000529	Box of 10 boxes with 100 pieces.
Blue	13006AZ/P	215mm x 120mm x 60mm	455g	7908057000512	Box of 10 boxes with 100 pieces.



POWDER DISPOSABLE VINYL GLOVE

Suitable for general use protecting the user in light and medium jobs.
Powdered glove. Not recommended for clinical or hospital use.

Color	Reference	Measure	Weight	Code Bars	Packing
Clear	13007/G	215mm x 120mm x 60mm	558g	7908057000567	Box of 10 boxes with 100 pieces.
Clear	13007/M	215mm x 120mm x 60mm	476g	7908057000550	Box of 10 boxes with 100 pieces.
Clear	13007/P	215mm x 120mm x 60mm	450g	7908057000543	Box of 10 boxes with 100 pieces.
Blue	13007AZ/G	215mm x 120mm x 60mm	540g	7908057000598	Box of 10 boxes with 100 pieces.
Blue	13007AZ/M	215mm x 120mm x 60mm	475g	7908057000581	Box of 10 boxes with 100 pieces.
Blue	13007AZ/P	215mm x 120mm x 60mm	455g	7908057000574	Box of 10 boxes with 100 pieces.





SUPERPRO PLUS PVC GLOVE

Made of powder-free polyvinyl chloride (PVC) with a smooth outer surface. It presents no flocked inner liner.

Color	Reference	Measure	Weight	Code Bars	Packing
● Yellow	SP13003/4G	295mm x 115mm	38g	7898509287458	Box with 48 units
● Yellow	SP13003/4M	295mm x 115mm	34g	7898509287441	Box with 48 units
● Yellow	SP13003/4P	295mm x 115mm	31.5 g	7898509287434	Box with 48 units



LONG WRIST CRACKED LATEX GLOVE

Unlined yellow latex glove. Fingers and palm hands with non-slip texture. Wrist with ferrule finish.

Color	Reference	Measure	Weight	Code Bars	Packing
● Yellow	SP13005/4G	390mm x 115mm	92g	7898509289735	Box with 48 units
● Yellow	SP13005/4M	390mm x 115mm	87g	7898509289728	Box with 48 units
● Yellow	SP13005/4P	390mm x 115mm	83g	7898509289711	Box with 48 units



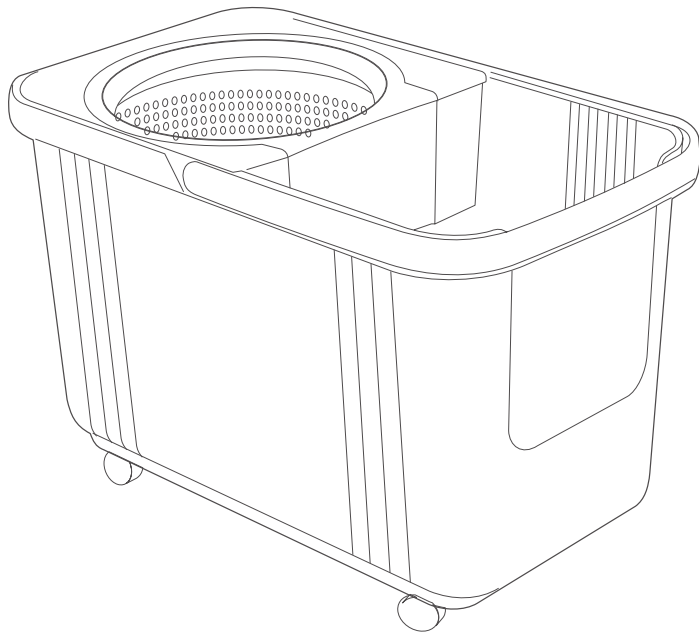

Buckets

SUPERPRO PLASTIC BUCKET 14L

14L bucket with drainer for mini mops. May be utilized with mini mops 9117P, SP9117AM, SP9117AZ, SP9117VD, SP9117VR, 9118 and SP9119.

Color	Reference	Measure	Weight	Code Bars	Packing
● Gray	9230	400mm x 310mm x 295mm	597g	7898509280763	Box with 6 units



DRAINERLESS BUCKET 14L

14L bucket with drainer for mini mops. May be utilized with mini mops 9117P, SP9117AM, SP9117AZ, SP9117VD, SP9117VR, 9118 and SP9119.

Color	Reference	Measure	Weight	Code Bars	Packing
● Gray	9278	400mm x 310mm x 295mm	466g	7898509280879	Box with 6 units



Made of sturdy material, SuperPro's various models of buckets and squeezers help with work and sanitation, as well as being easily transported. Today's press and wheel systems and water dividing buckets bring greater efficiency to your service.



14L OVAL BUCKET DRAINER.

Drainer ideal for mini mops.
May be used with buckets: 9278; 8040; SP9232

Color	Reference	Measure	Weight	Code Bars	Packing
● Black	9237	285mm x 200mm x 130mm	128g	7898509280770	Box with 6 units



PLASTIC BUCKET O2 WATERS WITH REAMER 20L

Innovative product with watershed, preventing contamination.
Because it is collapsible, it allows for storage in small spaces.

Color	Reference	Measure	Weight	Code Bars	Packing
● Gray	SP9232	575mm x 280mm x 285mm	1.26kg	7908057000093	Box with 4 units





> Buckets

2 WATER BUCKET DRAINER

SP9232 big bucket drainer.
Recommended for use with 300 g and 340 g mops.

Color	Reference	Measure	Weight	Code Bars	Packing
● Black	SP9232/1	274mm x 150mm x 215mm	205g	7908057000147	Box with 6 units



DOUBLE BUCKET WITH DRAINER 15L

Two-water bucket with capacity of 15L. Used with the 9117P, SP9117AM, SP9117AZ, SP9117VD, SP9117VR, 9118 and SP9119 mini mops.

Color	Reference	Measure	Weight	Code Bars	Packing
● Gray	9360	435mm x 275mm x 330mm	1.2kg	7898509282163	Box with 1 units



SUPERPRO OVAL BUCKET 19L

Ideal bucket for use with Sekito Mop (9300F and SP9340F).
May also be used with SP 9232/1 and 9237 baskets.

Color	Reference	Measure	Weight	Code Bars	Packing
● Gray	8040	490mm x 280mm x 270mm	520g	7898509282514	Bag with 6 unit





20L WATER DIVIDER REAMER BUCKET SET

Bucket set with water separator and horizontal displacement reamer.
Utilized with 300 g and 340 g mops.

Color	Reference	Measure	Weight	Code Bars	Packing
● Yellow	9068	630mm x 270mm x 670mm	3.83kg	7898509281586	Box with 1 unit



SIDE LEVER REAMER BUCKET SET 33L

Bucket set with water separator and horizontal displacement reamer.
Utilized with 300 g and 340 g mops.

Color	Reference	Measure	Weight	Code Bars	Packing
● Yellow	9077	595mm x 410mm x 900mm	9.5kg	7898509283641	Box with 1 unit



REAMER BUCKET SET 33L

Bucket set with vertical displacement reamer.
Utilized with 300 g and 340 g mops.

Color	Reference	Measure	Weight	Code Bars	Packing
● Yellow	9081	540mm x 425mm x 860mm	7.5kg	7898509281616	Box with 1 unit



> Buckets

PLASTIC BUCKET PRESS

Bucket set with vertical displacement reamer.
Utilized with 300 g and 340 g mops.

Color	Reference	Measure	Weight	Code Bars	Packing
● Yellow	9081/1	255mm x 290mm x 590mm	4,479g	7898509285249	Box with 1 unit



9077 BUCKET SQUEEZER

9077 Bucket Press.
Utilized with 300 g and 340 g mops.

Color	Reference	Measure	Weight	Code Bars	Packing
● Yellow	SP9077/1	300mm x 290mm x 640mm	3.3kg	7898509289605	Box with 1 unit



RED BUCKET ACCESSORY OF BUCKET 9077

Red 18 L bucket. It is a part of the 9077 bucket.

Color	Reference	Measure	Weight	Code Bars	Packing
● Red	SP9077B	510mm x 335mm x 270mm	2.5kg	7908057000857	Box with 1 unit





REAMER BUCKET SET 44L

Set with water separator bucket, vertical offset press, accessory holder and an extra blue 18L-capacity bucket. Used with 300 g and 340 g mops.

Color	Reference	Measure	Weight	Code Bars	Packing
● Yellow	SP9079	910mm x 505mm x 955mm	15kg	7898509287823	Box with 1 unit



PLASTIC PRESS FOR SP 9079 BUCKET

SP9079 bucket press. Utilized with 300 and 340g mops.

Color	Reference	Measure	Weight	Code Bars	Packing
● Yellow	SP9079/1	280mm x 270mm x 730mm	4.7kg	7908057000949	Box with 1 unit



VERTICAL REAMER BUCKET SET 25L

Bucket set with water separator and vertical displacement reamer. 15L capacity for each bucket. Utilized with 300 g and 340 g mops.

Color	Reference	Measure	Weight	Code Bars	Packing
● Red, Gray and Blue	9076	750mm x 430mm x 745mm	7.7kg	7898509281609	Box with 1 units



> Buckets

BUCKET AND SLIM MOP SET

Bucket with capacity of 5 liters of water and is intended for general floor cleaning. Includes 1.20 m handle and 01 microfiber mop. Handle (SP9085C), base (SP9085B), mops (SP9085R) and brush (SP9087) sold separately.

Color	Reference	Measure	Weight	Code Bars	Packing
 Gray and Red	SP9085	455mm x 250mm x 220mm	1.3kg	7908057000352	Box with 1 unit



COMPACT BUCKET AND MOP SET

Comes with 1.30m chromed steel handle, 01 microfiber mop and 01 microfiber cartridge. Bucket capacity of 5 liters. Presents two levels of job:
 1st - Mop wash by handle activation;
 2nd - Centrifugation of the mop.
 Handle (SP9096C), mops (SP9096R) and brush (SP9087) sold separately.

Color	Reference	Measure	Weight	Code Bars	Packing
 Black and Red	SP9096	265mm x \varnothing 330mm	2.5kg	7898509288691	Box with 1 unit



SUPERPRO MOP BUCKET

It presents basket in stainless steel and aluminum pedal. Comes with 1.40 m stainless steel handle, 01 microfiber mop and 01 microfiber refill. Bucket capacity of 6 liters. Handle (SP9086C), mops (SP9086/4R) and brush (SP9087) sold separately.

Color	Reference	Measure	Weight	Code Bars	Packing
 Gray and Red	SP9086	480mm x 290mm x 270mm	2.24 kg	7898509284945	Box with 1 unit





MOP AND PLASTIC BUCKET ASSEMBLY WITHOUT PEDAL

It has stainless steel centrifuge and modern design. Easy to clean and does not rust. It comes with an 1.30 m handle, 01 microfiber mop and 01 microfiber refill, 04 wheels, chemical doser and water drainage.

Maximum capacity of 8 liters. Handle (SP9090C), mops (SP9090R) and brush (SP9087) sold separately.

Color	Reference	Measure	Weight	Code Bars	Packing
 Black and Red	SP9090	470mm x 280mm x 290mm	4.13Kg	7898509287724	Box with 1 unit



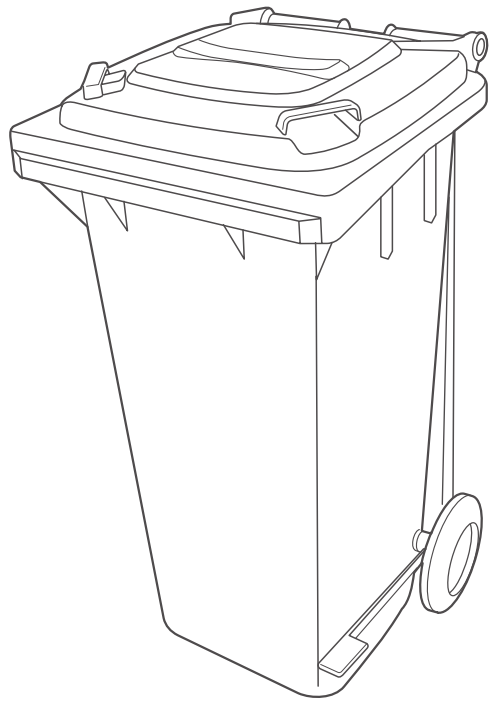

Trash cans

60L TILT PLASTIC DUMPSTER

60L trash bin with side handle.

Color	Reference	Measure	Weight	Code Bars	Packing
White and Green	9256	410mm x 313mm x 740mm	1.2kg	7898509281692	Box with 6 units



PLASTIC TRASH BIN WITH PEDAL 13.5L

13.5 L trash bin with pedal-operated lid.

Color	Reference	Measure	Weight	Code Bars	Packing
White and Beige	9351	27 mm x 252mm x 370mm	494g	7898509282002	Box with 6 units



SuperPro dumpsters are suitable for indoor and outdoor areas. Available in different colors, capacities and models, they meet the most varied establishments and needs.



36L PLASTIC DUMPSTER WITH PEDAL

36L trash bin with pedal-operated lid.

Color	Reference	Measure	Weight	Code Bars	Packing
White and Green	9356B	390mm x 335mm x 535mm	1.13kg	7898509282064	Box with 3 units
White and Green	9356	390mm x 335mm x 535mm	1.13kg	7898509282057	Box with 3 units



72L Plastic Trash Can with Pedal

72L trash bin with pedal-operated lid.

Color	Reference	Measure	Weight	Code Bars	Packing
White and Green	9357	480mm x 410mm x 660mm	1.93kg	7898509282071	Box with 3 units
White	9357B	480mm x 410mm x 660mm	1.93kg	7898509282088	Box with 3 units



> Trash cans

PLASTIC TRASH CAN WITH PEDAL

Activation of lid by the pedal, indicated for internal and external areas.
Available in various colors. They serve the most varied establishments and needs. Available 9358 120 L and 9359 240 L.

Color	Reference	Measure	Weight	Code Bars	Packing
Yellow	9358AM	550mm x 470mm x 900mm	7.3kg	7898509282095	Box with 1 unit
Blue	9358AZ	550mm x 470mm x 900mm	7.3kg	7898509282101	Box with 1 unit
White	9358BR	550mm x 470mm x 900mm	7.3kg	7898509283924	Box with 1 unit
Gray	9358CZ	550mm x 470mm x 900mm	7.3kg	7898509282118	Box with 1 unit
Green	9358VD	550mm x 470mm x 900mm	7.3kg	7898509282125	Box with 1 unit
Brown	SP9358MR	550mm x 470mm x 900mm	7.3kg	7898509285485	Box with 1 unit
Red	9358VR	550mm x 470mm x 900mm	7.3kg	7898509283191	Box with 1 unit
Yellow	9359AM	710mm x 560mm x 1010mm	10.5kg	7898509283214	Box with 1 unit
Blue	9359AZ	710mm x 560mm x 1010mm	10.5kg	7898509282132	Box with 1 unit
White	9359BR	710mm x 560mm x 1010mm	10.5kg	7898509283931	Box with 1 unit
Gray	9359CZ	710mm x 560mm x 1010mm	10.5kg	7898509282149	Box with 1 unit
Green	9359VD	710mm x 560mm x 1010mm	10.5kg	7898509282156	Box with 1 unit
Brown	SP9359MR	710mm x 560mm x 1010mm	10.5kg	7898509285508	Box with 1 unit
Red	9359VR	710mm x 560mm x 1010mm	10.5kg	7898509283207	Box with 1 unit



120L PLASTIC DUMPSTER WITH PEDAL

Plastic dumpsters with pedal. Activation of lid by the pedal, indicated for indoor and outdoor areas. Suitable for in and outdoor areas. Available in different colors, capacities and models, they meet the most varied establishments and needs.

Color	Reference	Measure	Weight	Code Bars	Packing
Yellow	SP9358AM/3	90x55cm	73g	7898509284785	3 units
Blue	SP9358AZ/3	90x55cm	73g	7898509284792	3 units
White	SP9358BR/3	90x55cm	73g	7898509284808	3 units
Gray	SP9358CZ/3	90x55cm	73g	7898509284815	3 units
Brown	SP9358MR/3	90x55cm	73g	7898509285492	3 units
Green	SP9358VD/3	90x55cm	73g	7898509284822	3 units
Red	SP9358VR/3	55x95cm	73g	7898509284839	3 units





240L PLASTIC DUMPSTER WITH PEDAL

Plastic dumpsters with pedal. Activation of lid by the pedal, indicated for indoor and outdoor areas. Suitable for in and outdoor areas. Available in different colors, capacities and models, they meet the most varied establishments and needs.

Color	Reference	Measure	Weight	Code Bars	Packing
Yellow	SP9359AM/3	71x101cm	10.5kg	7898509284846	Bag with 3 unit
Blue	SP9359AZ/3	71x101cm	10.5kg	7898509284853	Bag with 3 unit
White	SP9359BR/3	71x101cm	10.5kg	7898509284860	Bag with 3 unit
Gray	SP9359CZ/3	71x101cm	10.5kg	7898509284877	Bag with 3 unit
Green	SP9359VD/3	71x101cm	10.5kg	7898509284884	Bag with 3 unit
Red	SP9359VR/3	71x101cm	10.5kg	7898509284891	Bag with 3 unit
Brown	SP9359MR/3	71x101cm	10.5kg	7898509285515	Bag with 3 unit



PLASTIC DUMPSTER WITH PEDAL

White trash can with lid activation by pedal. Mainly suitable for hospital areas and restaurants. Available in 15 L, 25 L, 30 L, 45 L, 60 L and 87 L.

Color	Reference	Measure	Weight	Code Bars	Packing
White	SP93515BR	315mm x 250mm x 400mm	915g	7898509286260	Box with 8 units
White	SP93525BR	355mm x 325mm x 487mm	1.4kg	7898509286277	Box with 4 units
White	SP93530BR	395mm x 400mm x 380mm	2.3g	7898509286291	Box with 4 units
White	SP93545BR	395mm x 400mm x 610mm	3kg	7898509286314	Box with 4 units
White	SP93560BR	480mm x 380mm x 670mm	4.1kg	7898509286338	Box with 3 units
White	SP93587BR	480mm x 380mm x 830mm	4.8kg	7898509286352	Box with 3 units



STAINLESS STEEL TRASH CAN WITH PEDAL

Stainless steel trash can, lid activation by pedal. Modern design and easy to clean. Removable plastic inner basket. Available in stainless steel colors. (5 L, 12 L, 20 L and 30 L) and matte black (5 L and 12 L).

Color	Reference	Measure	Weight	Code Bars	Packing
Stainless Steel	SP93705	275mm x Ø 250mm	850g	7898509289124	Box with 4 units
Black	SP93705PR	275mm x Ø 250mm	850g	7908057000864	Box with 4 units
Stainless Steel	SP93712	390mm x Ø 250mm	2.07kg	7898509287885	Box with 4 units
Black	SP93712PR	390mm x Ø 250mm	2.07kg	7908057000871	Box with 4 units
Stainless Steel	SP93720	440mm x Ø 290mm	2.55kg	7898509287892	Box with 2 units
Stainless Steel	SP93730	650mm x Ø 290mm	3.9kg	7898509287908	Box with 2 units



Trolleys

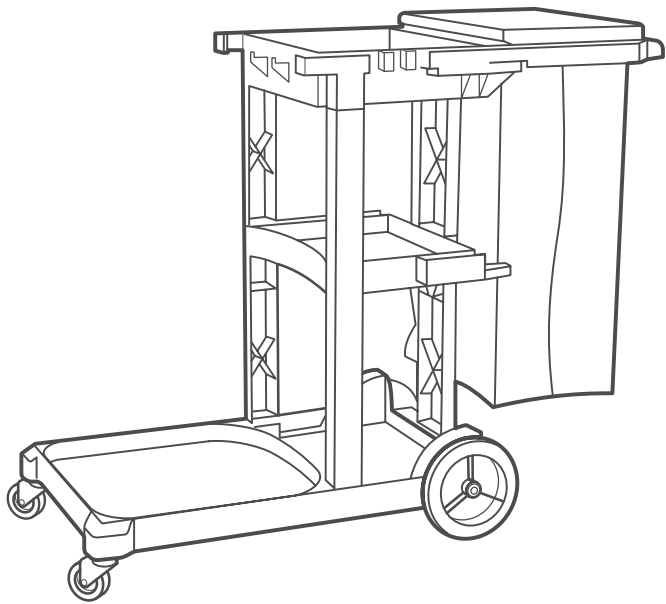

FUNCTIONAL TROLLEY WITH BAG

Trolley with molded compartments that make it possible to organize a variety of accessories and equipment and make it easy to move.

It has 1 base and 2 shelves, vinyl bag with capacity for 60 liters.

Front wheels (9160RD), rear wheels (9160RT), vinyl pouch (9160SC) and cover (9160TP) are sold separately.

Color	Reference	Measure	Weight	Code Bars	Packing
● Gray	9160	1190mm x 520mm x 995mm	12.6kg	7898509281623	Box with 1 unit



9160 TROLLEY FRONT WHEEL

Suitable for the 9160 Trolley.

Color	Reference	Measure	Weight	Code Bars	Packing
● Gray	9160RD	∅ 75mm x 21mm x 130mm	285g	7898509285256	Box with 2 units

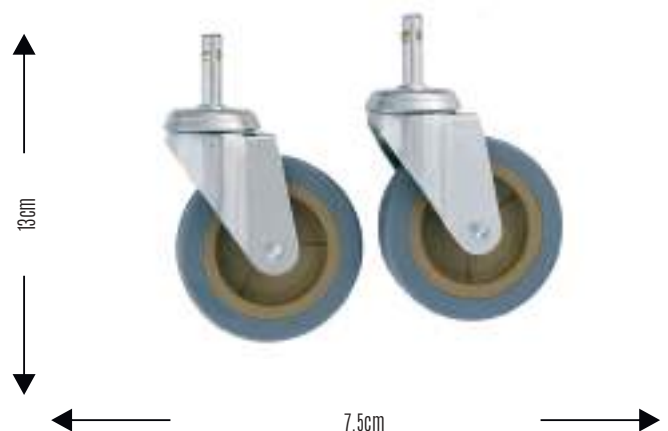

Designed to optimize productivity and sanitation efficiency of different environments. SuperPro functional trolleys have spaces for all kinds of accessories and equipment, making user service easier and increasing productivity.



9160 TROLLEY REAR WHEEL

Suitable for the 9160 Trolley.

Color	Reference	Measure	Weight	Code Bars	Packing
● Gray	9160RT	40mm x Ø 205mm	765g	7898509283009	Box with 2 units



VINYL BAG FOR 9160 TROLLEY

Vinyl Bag for 9160 Trolley.
60 L capacity.

Color	Reference	Measure	Weight	Code Bars	Packing
● Yellow	9160SC	700mm x 380mm	335g	7898509283276	Box with 3 units



> Trolleys

PLASTIC HOTEL TROLLEY

Unique design that makes it indispensable for the hotel, fast food, hospital sectors, among others. It has 1 base and 2 adjustable internal shelves. Comes with 2 vinyl canvas bags with a capacity of 85 liters each.

Color	Reference	Measure	Weight	Code Bars	Packing
● Gray	9170	1525mm x 545mm x 1285mm	42kg	7898509282996	Box with 1 unit



HIGH CAPACITY BLACK TROLLEY

The cart comes with a 60 L zippered pouch that facilitates removal of loaded material. Molded compartments that organize a variety of accessories and equipment. It has a modern and bold design, 1 base and 2 shelves. Vinyl pouch (SP9161/1) and accessory holder (SP9161/2) are sold separately.

Color	Reference	Measure	Weight	Code Bars	Packing
● Black	SP9161	1129mm x 535mm x 995mm	13.7kg	7898509286536	Box with 1 units



SP9161 MULTIPURPOSE TROLLEY HOLDER

Product organizer holder for use with the SP 9161 or 9160 trolley. 17cm deep.

Color	Reference	Measure	Weight	Code Bars	Packing
● Black	SP9161/2	385mm x 275mm x 170mm	510g	7898509286550	Box with 3 units

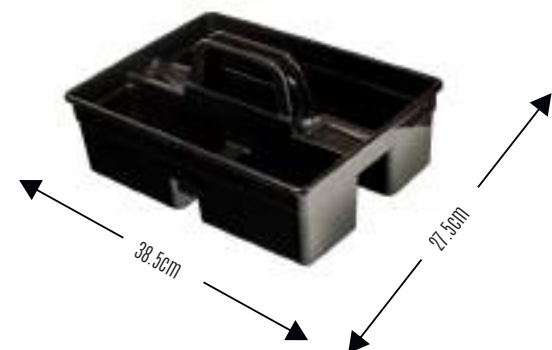



BLACK SHELF CART

Trolley with molded compartments that make it possible to organize a variety of accessories and equipment and make it easy to move. It has 1 foundation and 2 shelves, with option for a third shelf. Extra shelf (SP9165/1), side cover assembly (SP9165/2) and wheels (SP9165/3) are sold separately.

Color	Reference	Measure	Weight	Code Bars	Packing
● Black	SP9165	830mm x 410mm x 850mm	13.8kg	7898509286482	Box with 1 unit



LARGE SHELF CART

Utility cart. Made of plastic, it makes the car quieter and easier to clean. Capacity by shelf: 60 kg; Deepness: 52.5cm

Color	Reference	Measure	Weight	Code Bars	Packing
● Black	SP9167	1110mm x 525mm x 920mm	13.7g	7898509287793	Box with 1 unit



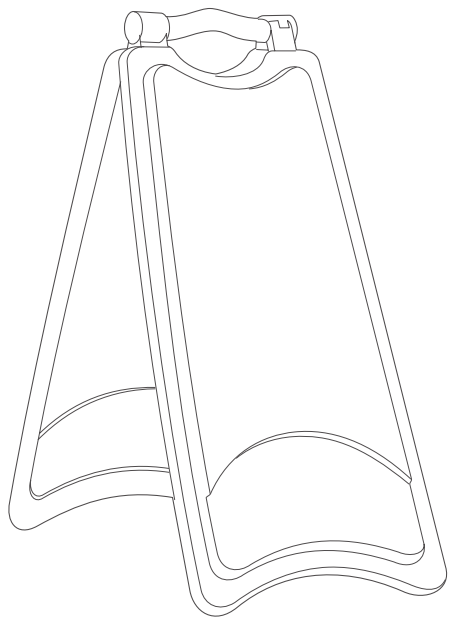

Boards and Signs

SIGNPOST "CLOSED BATHROOM"

Suitable for closed bathroom signage.

Color	Reference	Measure	Weight	Code Bars	Packing
● Yellow	9244B	620mm x 280mm x 25mm	790g	7898509280787	Box with 3 units



"UNDER MAINTENANCE" WARNING SIGN

Ideal for signaling areas under maintenance.

Color	Reference	Measure	Weight	Code Bars	Packing
● Yellow	9247B	620mm x 280mm x 25mm	790g	7898509286826	Box with 3 units



Part of safety equipment, SuperPro signposts are indispensable in the institutional environment. Made of sturdy material, they are available with a variety of warning messages to inform floor or environmental conditions and prevent accidents.



“WET FLOOR” SIGNPOST

Suitable for wet floor signage.

Color	Reference	Measure	Weight	Code Bars	Packing
● Yellow	9248B	620mm x 280mm x 25mm	790g	7898509280817	Box with 3 units



Dispensers

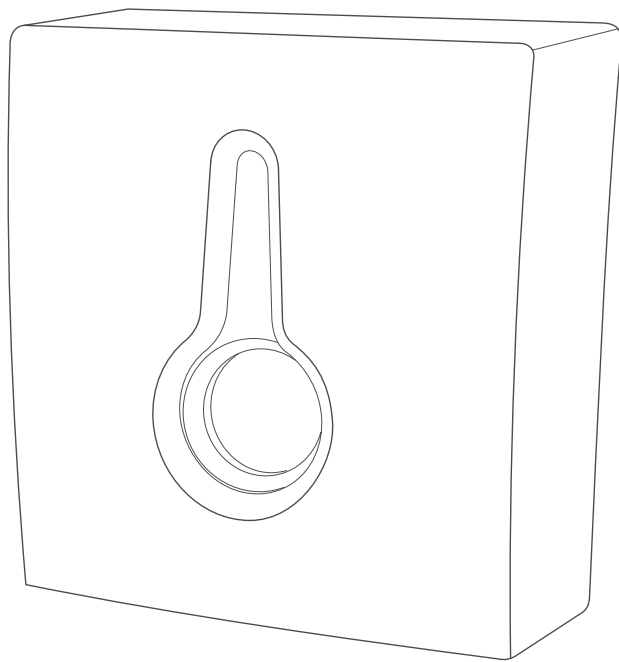

PLASTIC HOLDER FOR HYGIENIC PAPER

Developed in highly resistant plastic with modern and practical design for everyday use. Capacity: rolls of 300m

Color	Reference	Measure	Weight	Code Bars	Packing
● White	9700	280mm x 275mm x 125mm	593g	7898509282217	w/ 6 units



PLASTIC HOLDER FOR PAPER TOWEL

Capacity: 500 2-fold sheets or 250 3-fold sheets

Color	Reference	Measure	Weight	Code Bars	Packing
● White	9701	315mm x 250mm x 132mm	447g	7898509282224	Box with 6 units



Easy to handle and sanitize, dispensers are practical and available to fulfill key functions in high-circulation toilets. They are sturdy and easy to install.



PLASTIC HOLDER FOR LIQUID SOAP

Reservoir with capacity of 800mL. Also sold option without reservoir (SP9702/6).
Valve sold separately (SP9702V).

Color	Reference	Measure	Weight	Code Bars	Packing
● White	9702	250mm x 120mm x 125mm	468g	7898509282231	Box with 14 units
● White	9702R	220mm x 90mm x 85mm	97g	7898509282248	Box with 14 units



MOUTH NAPKIN HOLDER

Capacity for 100 - 125 sheets.

Color	Reference	Measure	Weight	Code Bars	Packing
● White	SP9704	145mm x 125mm x 90mm	170g	7898509285393	Box with 14 units



> Dispensers

PLASTIC PAPER TOWEL HOLDER LEVER

Recommended for coils 20 cm wide and 200 m long.

Color	Reference	Measure	Weight	Code Bars	Packing
● White	SP9705	275mm x 255mm x 340mm	1.7kg	7898509285409	Box with 1 unit



COMPACT AUTO CUTTING PLASTIC TOWEL HOLDER

It has a self-cutting paper towel system that prevents the touch of hands with the device. Ideal for use in hospitals, clinics and the food industry where there should be no contact contamination of the hands.

Dispenser made of high quality thermoplastic material and impact resistance. Easy installation with included screws and dowels and safety lock with cross key. Indicated for use in: bars, restaurants, clinics, offices, factories, hospitals, etc. Supports rollers up to 173 mm in diameter (200 meters).

Color	Reference	Measure	Weight	Code Bars	Packing
● White	SP9715	330mm x 315mm x 185mm	1.95kg	7898509289131	Box with 1 unit



COMPACT PLASTIC HOLDER FOR SOAP FOAM

Contains 500 mL reservoir and foam valve. Suitable for foam soaps. Reservoir sold separately (SP9716R)

Color	Reference	Measure	Weight	Code Bars	Packing
● White	SP9716	105mm x 97mm x 200mm	330g	7898509289148	Box with 6 units





PLUS PLASTIC HOLDER FOR TOILET PAPER

Developed in highly resistant plastic with modern and practical design for everyday use. Capacity: rolls of 300m

Color	Reference	Measure	Weight	Code Bars	Packing
● Tinted	SP9720	280mm x 275mm x 125mm	593g	7908057000307	Box with 6 units



PLUS PLASTIC HOLDER FOR TOWEL PAPER

Capacity: 500 2-fold sheets or 250 3-fold sheets

Color	Reference	Measure	Weight	Code Bars	Packing
● Tinted	SP9721	315mm x 250mm x 132mm	447g	7908057000314	Box with 6 units



PLUS PLASTIC HOLDER FOR LIQUID SOAP

Recommended for liquid soaps. Easy handling, convenient to clean and install.
Reservoir with capacity of 800 mL.
Reservoir and valves sold separately (9702R and SP9702V)

Color	Reference	Measure	Weight	Code Bars	Packing
● Tinted	SP9722	250mm x 120mm x 125mm	468g	7908057000321	Box with 6 units





> Dispensers

PLASTIC PLUS NAPKIN HOLDER

Capacity for 100 - 125 sheets.

Color	Reference	Measure	Weight	Code Bars	Packing
● Tinted	SP9724	145mm x 125mm x 90mm	170g	7908057000338	Box with 6 units





SuperPro
* BETTANIN



Garbage Bags

SUPERPRO TRASH BAGS 40L

Resistant and reinforced for waste collection.
 Contains 10 packs of 100 pieces each.
 Lifting Resistance: 10kg
 Micra: 25 microns total (12.5 per wall)

Color	Reference	Measure	Weight	Code Bars	Packing
● Black	SP18040PR	58cm x 52cm	8g	7908057000260	10 packages with 100 units



SUPERPRO TRASH BAGS 60L

Resistant and reinforced for waste collection.
 Contains 10 packs of 100 pieces each.
 Lifting Resistance: 15 kg
 Micra: 25 microns total (12.5 per wall)

Color	Reference	Measure	Weight	Code Bars	Packing
● Black	SP18060PR	70 x 57cm	10g	7898509289919	10 packages with 100 units



Superpro trash bags ensure more resistance and safety for the user, as it has a reinforced bottom, which prevents excess pressure on the sides, better distributing the waste inside the bag. For commercial and institutional use, it comes in several sizes.



SUPERPRO TRASH BAGS 100L

Resistant and reinforced for waste collection.
Contains 05 packs of 100 pieces each.
Lifting Resistance: 20 kg
Micra: 30 microns total (15 per wall)

Color	Reference	Measure	Weight	Code Bars	Packing
● Black	SP18100PR	90cm x 75cm	20g	7908057000277	5 packages with 100 units



SUPERPRO TRASH BAGS 105L

Resistant and reinforced for waste collection.
Contains 05 packs of 100 pieces each.
Lifting Resistance: 20 kg
Micra: 30 microns total (15 per wall)

Color	Reference	Measure	Weight	Code Bars	Packing
● Black	SP18105PR	95cm x 75cm	20g	7898509289926	5 packages with 100 units



> Trash Bags

SUPERPRO TRASH BAGS 150L

Resistant and reinforced for waste collection.

Contains 02 packs of 100 pieces each.

Lifting Resistance: 30 kg

Micra: 30 microns total (15 per wall)

Color	Reference	Measure	Weight	Code Bars	Packing
● Black	SP18150PR	100cm x 85cm	26g	7908057000291	2 packages with 100 units



SUPERPRO TRASH BAGS 200L

Resistant and reinforced for waste collection.

Contains 01 packs of 50 pieces each.

Lifting resistance: 35 kg

Micra: 50 microns total (25 per wall)

Color	Reference	Measure	Weight	Code Bars	Packing
● Black	SP18200PR	130cm x 100cm	59g	7908057000284	1 package with 50 units





SuperPro

 **BETTANIN**



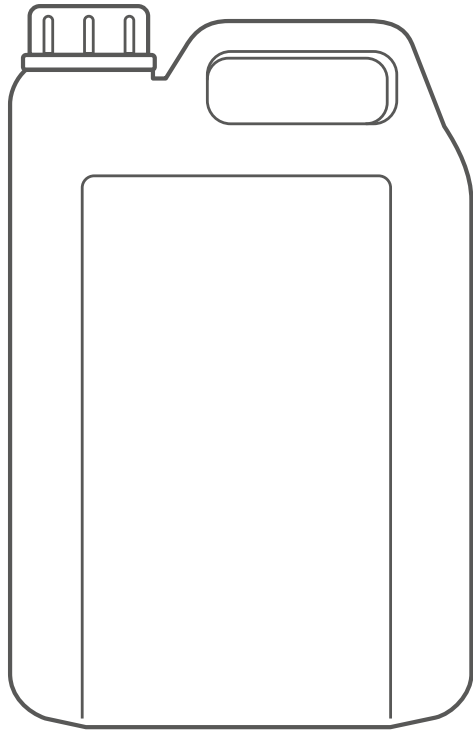

Chemicals

LIMP PRO 5L REMOVER

LimpPro is an efficient acrylic wax and finish remover with high penetration and emulsification power.

Color	Reference	Measure	Weight	Code Bars	Packing
Violet	SP15100	185mm x 140mm x 285mm	5.3kg	7898509283955	Box with 2 units



5L BASE REMOVER

Base Remover is an efficient High Speed (HS) and Ultra High Speed (UHS) wax remover, with high penetration and emulsification.

Color	Reference	Measure	Weight	Code Bars	Packing
Colorless	SP15110	185mm x 140mm x 285mm	5.3kg	7898509283962	Box with 2 units



Developed with refined sanitizing properties and superior characteristics, our chemicals line provides excellent results in floor cleaning, treatment and maintenance, as well as excellent performance.



PROSEL 5L ACRYLIC SEALER

ProSel is an aqueous based acrylic sealer for vinyl and cold floors such as granilite, concrete, marmorite, ceramic, slate, etc.

Color	Reference	Measure	Weight	Code Bars	Packing
● White	SP15250	185mm x 140mm x 285mm	5.3kg	7898509285775	Box with 2 units



5L PRORUA ACRYLIC FINISH SEALER

ProRua is a High Gloss Finisher and a Sealer in a single product.

Color	Reference	Measure	Weight	Code Bars	Packing
● White	SP15260	185mm x 140mm x 285mm	5.3kg	7898509285782	Box with 2 units



> Chemicals

LUMIPRO 5L ACRYLIC FINISH

LumiPro is a self-gloss acrylic waterproofing formulated with metalized polymers that provide a durable and shiny protective film to the floor.

Color	Reference	Measure	Weight	Code Bars	Packing
● White	SP15800	185mm x 140mm x 285mm	5.3kg	7898509285799	Box with 2 units



LUMISUPER PLUS 5L ACRYLIC FINISH

LumiSuper Plus is an acrylic finish for heavy traffic floors, providing excellent strength, high gloss finishes with unsurpassed hardness and durability, allowing for restoration with HS and UHS waxes.

Color	Reference	Measure	Weight	Code Bars	Packing
● White	SP15810	185mm x 140mm x 285mm	5.3kg	7898509285805	Box with 2 units



LUMISUPER 5L ACRYLIC FINISH

LumiSuper an acrylic finish for heavy traffic floors, providing excellent strength, high gloss finishes with unsurpassed hardness and durability, allowing for restoration with HS and UHS waxes. Features non-slip action and wet shine appearance.

Color	Reference	Measure	Weight	Code Bars	Packing
● White	SP15820	185mm x 140mm x 285mm	5.3kg	7898509285812	Box with 4 units





HIGIPRO 5L DETERGENT

HigiPro is a high efficiency concentrated detergent suitable for removing tough soils such as oil, grease and fats.

Color	Reference	Measure	Weight	Code Bars	Packing
● Green	SP15000	185mm x 140mm x 285mm	5.3kg	7898509283948	Box with 2 units



OXY PRO 5L DETERGENT

OxyPro is a powerful and versatile general purpose concentrated cleaner formulated with modern surfactants and hydrogen peroxide.

Color	Reference	Measure	Weight	Code Bars	Packing
● Blue	SP155305	185mm x 140mm x 285mm	5.3kg	7898509289230	Box with 2 units



5L PRO DEGREASER

Pro Degreaser is a concentrated, fragrance-free, biodegradable alkaline degreaser designed for cleaning any washable surface such as formics, plastics, cabinets, machine and equipment parts, hoods, ovens, cold floors, etc.

Color	Reference	Measure	Weight	Code Bars	Packing
● White	SP15450	185mm x 140mm x 285mm	5.3kg	7908057000727	Box with 2 units



> Chemicals

5L LAVENDER DISINFECTANT

The Disinfectant Cleaner Lavender cleans, disinfects and perfumes surfaces and environments such as floors, walls, sanitary ware, drains, garbage dumps, surfaces in general, eliminating smelly microorganisms.

Color	Reference	Measure	Weight	Code Bars	Packing
 Violet	SP15560	185mm x 140mm x 285mm	5.3kg	7898509288769	Box with 2 units



5L Z40 DISINFECTANT

The Disinfectant Cleaner Z40 cleans, disinfects and perfumes surfaces and environments such as floors, walls, sanitary ware, drains, garbage dumps, surfaces in general, eliminating smelly microorganisms.

Color	Reference	Measure	Weight	Code Bars	Packing
 Lilac	SP15561	185mm x 140mm x 285mm	5.3kg	7898509288776	Box with 2 units



5L DESOLIMP DISINFECTANT

The Disinfectant Cleaner Desolimp cleans, disinfects and perfumes surfaces and environments such as floors, walls, sanitary ware, drains, garbage dumps, surfaces in general, eliminating smelly microorganisms.

Color	Reference	Measure	Weight	Code Bars	Packing
 Blue	SP15562	185mm x 140mm x 285mm	5.3kg	7898509288783	Box with 2 units





MAXIPRO 5L GENERAL PURPOSE CONCENTRATED CLEANER

MaxiPro is a multipurpose detergent recommended for daily cleaning of any washable hard surface such as formic, partition, vinyl, plastic, tile, metal, marble, porcelain, granite, etc.

Color	Reference	Measure	Weight	Code Bars	Packing
Colorless	SP15520	185mm x 140mm x 285mm	5.3kg	7898509286376	Box with 2 units



PLATE CLEANER 1L

Plate Cleaner is a ready-to-use chemical for cleaning plates and grids with burnt or encrusted fat.

Color	Reference	Measure	Weight	Code Bars	Packing
Yellow	SP15510	252mm x \varnothing 85mm	1.05kg	7898509286031	Box with 8 units



GLASS/STAINLESS STEEL CLEANER 2 IN 1 5L

The Glass/Stainless Steel Cleaner is a product specially formulated to clean and degrease surfaces of glass, stainless steel, aluminum, steel, enameled, which are common in elevators, refrigerators, hoods, stoves, countertops, bathroom metals and household items.

Color	Reference	Measure	Weight	Code Bars	Packing
Blue	SP15430	185mm x 140mm x 285mm	5.3kg	7908057000710	Box with 2 units



> Chemicals

CLEAN PINE DEGREASER

Clean Pine is a general purpose degreasing gel detergent with excellent cleaning power.

Color	Reference	Measure	Weight	Code Bars	Packing
● Yellow	SP15460	185mm x 140mm x 285mm	5.3kg	7908057001021	Box with 2 units



5L PEARLED LIQUID SOAP

Product intended for cleaning hands.

Color	Reference	Measure	Weight	Code Bars	Packing
● White	SP15603	185mm x 140mm x 285mm	5.3kg	7898509288745	Box with 4 units



MARINE LIQUID SOAP 5L

Product intended for cleaning hands.

Color	Reference	Measure	Weight	Code Bars	Packing
● Blue	SP15604	185mm x 140mm x 285mm	5.3kg	7898509288752	Box with 4 units





BACTERICIDE LIQUID SOAP 5L

Suitable for use in clinics, hospitals and places requiring bacteria elimination.

Color	Reference	Measure	Weight	Code Bars	Packing
Colorless	SP15605	185mm x 140mm x 285mm	5.3kg	7898509289179	Box with 4 units



LAVENDER TOUCH LIQUID SOAP 5L

Product intended for cleaning hands.

Color	Reference	Measure	Weight	Code Bars	Packing
● Lilac	SP15607	185mm x 140mm x 285mm	5.3kg	7898509289957	Box with 4 units



CHERRY WITH HAZELNUT LIQUID SOAP

Product intended for cleaning hands.

Color	Reference	Measure	Weight	Code Bars	Packing
● Red	SP15608	185mm x 140mm x 285mm	5.3kg	7898509289964	Box with 4 units



> Chemicals

AÇAÍ LIQUID SOAP

Product intended for cleaning hands.

Color	Reference	Measure	Weight	Code Bars	Packing
● Violet	SP15609	185mm x 140mm x 285mm	5.3kg	7898509289971	Box with 4 units



GRAPE LIQUID SOAP 5L

Product intended for cleaning hands.

Color	Reference	Measure	Weight	Code Bars	Packing
● Violet	SP15610	185mm x 140mm x 285mm	5.3kg	7898509289988	Box with 4 units



APPLE BLOSSOM LIQUID SOAP 5L

Product intended for cleaning hands.

Color	Reference	Measure	Weight	Code Bars	Packing
● Green	SP15611	185mm x 140mm x 285mm	5.3kg	7898509289995	Box with 4 units





LIQUID SOAP GREEN APPLE FOAM

Product intended for cleaning hands.

Color	Reference	Measure	Weight	Code Bars	Packing
● Green	SP15602	185mm x 140mm x 285mm	5.3kg	7898509285072	Box with 4 units



CHAMOMILE LIQUID SOAP 5L

Product intended for cleaning hands.

Color	Reference	Measure	Weight	Code Bars	Packing
● Yellow	SP15600	185mm x 140mm x 285mm	5.3kg	7898509285058	Box with 4 units



PEARLY FENNEL LIQUID SOAP 5L

Product intended for cleaning hands.

Color	Reference	Measure	Weight	Code Bars	Packing
● Green	SP15601	185mm x 140mm x 285mm	5.3kg	7898509285065	Box with 4 units





URINAL SCREEN

Keeps urinal sanitized and reduces odor.

Color	Reference	Measure	Weight	Code Bars	Packing
Blue	SP9102AZ	230mm x 220mm x 50mm	39g	7898509283887	Box with 12 units
Lilac	SP9102LA	230mm x 220mm x 50mm	39g	7898509283900	Box with 12 units
Green	SP9102VD	230mm x 220mm x 50mm	39g	7898509283870	Box with 12 units

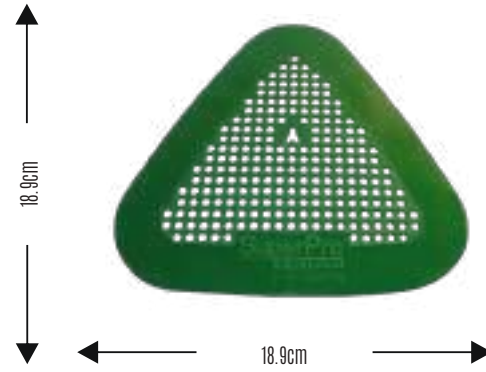

ANTI SPLASH URINAL SCREEN

New anti-splash urinal screen, designed to last 3 times longer than conventional, and has the innovative mechanism that prevents splash during use, thus not contaminating the environment.

Color	Reference	Measure	Weight	Code Bars	Packing
Purple	SP9104LA	190mm x 190mm x 15mm	95g	7908057000406	Box with 6 units
Green	SP9104VD	190mm x 190mm x 15mm	95g	17908057000410	Box with 6 units

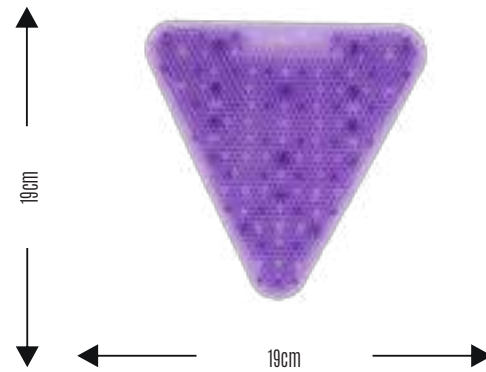

SuperPro

BETTANIN

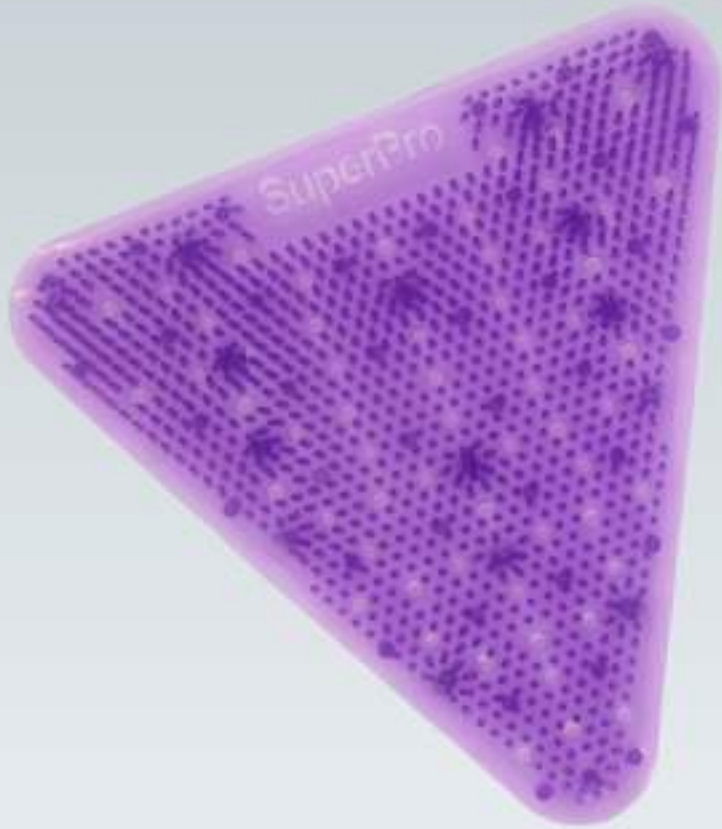

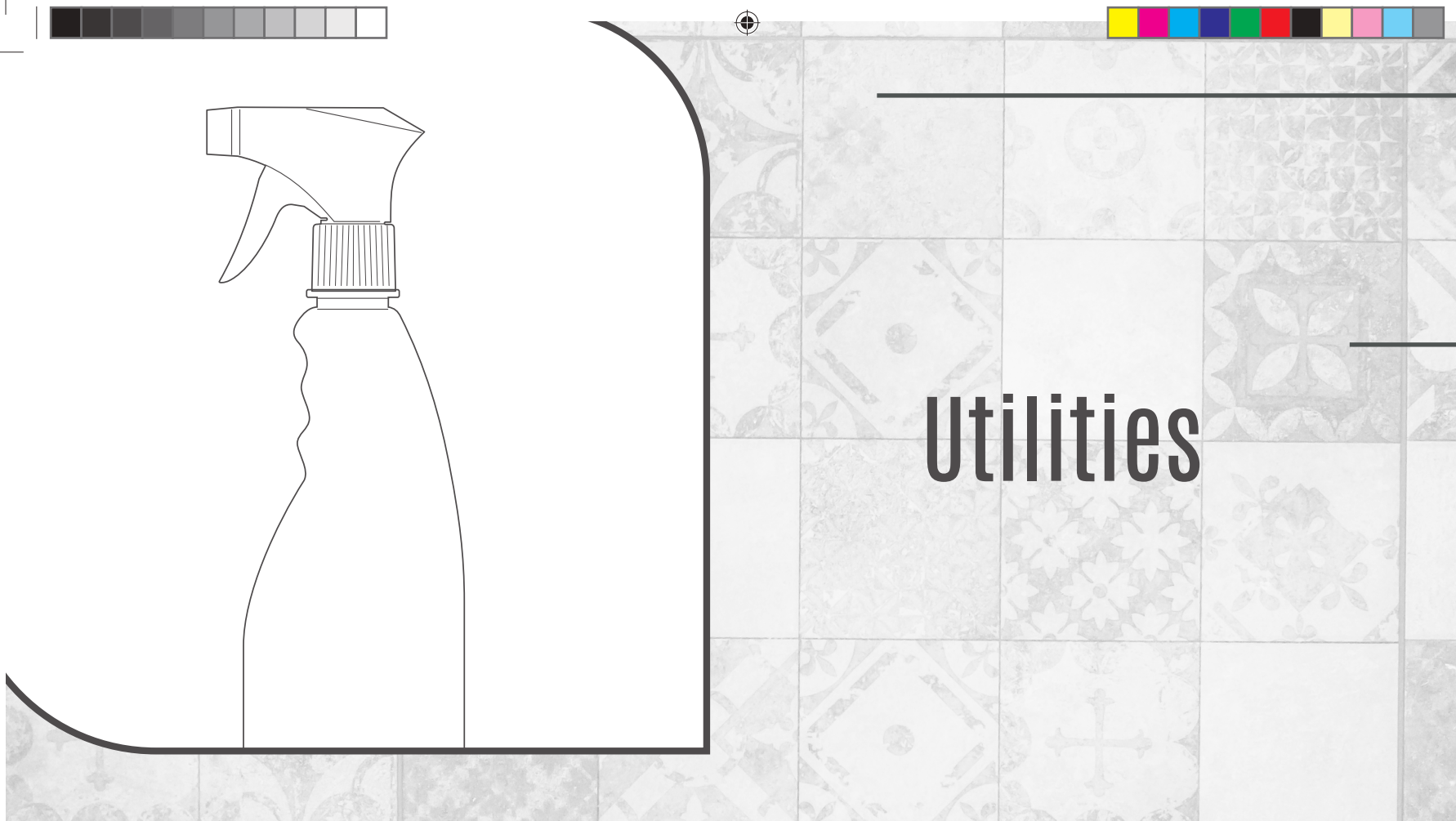

CLEANING EQUIPMENT ORGANIZER

Cleaning equipment organizer. 7 handles capacity.

Color	Reference	Measure	Weight	Code Bars	Packing
● Gray	SP8400	280mm x 90mm x 67mm	350g	7898509284129	Box with 12 units



CLEANING EQUIPMENT ORGANIZER

Cleaning equipment organizer. 11 handles capacity.

Color	Reference	Measure	Weight	Code Bars	Packing
● Gray	SP8401	440mm x 95mm x 70mm	500g	7898509284136	Box with 12 units

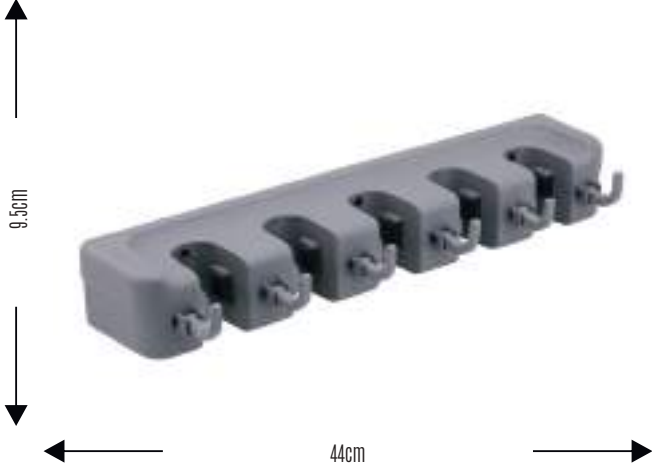

In order to streamline the process of organizing and sanitizing the most diverse environments, SuperPro presents a line of utilities to streamline processes and increase productivity without wearing out the user.



VACUUM PLUNGER

With rubber base, unclog drains and sinks.

Color	Reference	Measure	Weight	Code Bars	Packing
● Gray	SP8500	450mm x Ø 165mm	200g	7898509284068	Box with 12 units



TRANSPARENT 500ML PLASTIC SPRAY

Sprayer made of plastic with valve that allows the liquid to come out as a spray or foam.

Color	Reference	Measure	Weight	Code Bars	Packing
● Clear	SP9347	90mm x 65mm x 260mm	68g	7898509289568	Box with 12 units



> Utilities

500ML PLASTIC SPRAY

Sprayer developed in plastic with valve that allows for the application of chemicals.

Color	Reference	Measure	Weight	Code Bars	Packing
Blue	SP9348	83mm x 65mm x 256mm	50g	7898509281975	Box with 12 units



500ML SOAP DISH

Soap dish for liquid soap. Capacity of 500 mL.

Color	Reference	Measure	Weight	Code Bars	Packing
Clear	SP9708	90mm x 70mm x 204mm	46.5g	7898509285539	Box with 12 units



FOAM SOAP DISH 500 ML

Soap dish for foam soap. Capacity of 500 mL.

Color	Reference	Measure	Weight	Code Bars	Packing
Clear	SP9709	200 mm x \varnothing 73 mm	46.5g	7898509286024	Box with 12 units





1L MULTIPURPOSE SPRAYER

Ideal for insecticide, fungicide, plant humidification and general hygiene applications. Adjustable jet nozzle.

Color	Reference	Measure	Weight	Code Bars	Packing
White and Red	SP97181	190mm x 110mm x 295mm	319g	7898509289278	Box with 6 units



2L PLASTIC MULTI-USE SPRAY

Ideal for insecticide, fungicide, plant humidification and general hygiene applications. Adjustable jet nozzle.

Color	Reference	Measure	Weight	Code Bars	Packing
White and Red	SP97182	190mm x 130mm x 320mm	366g	7898509289285	Box with 6 units





ISSA é a principal associação comercial da indústria no setor de limpeza no mundo, com mais de 5.500 empresas associadas.

ISSA es la principal asociación comercial de la industria del sector de limpieza del mundo, con más de 5.500 empresas asociadas.

ISSA is the main business association of the cleaning sector industry, with more than 5,500 associated companies.

SuperPro
* **BETTANIN**

SUPERPROBETTANIN
BR 116 - Km 258 - Esteio/RS
CEP 93270-000
Telephone: 55 (51) 3459.7778
SAC 0800 0078145
www.superprobettanin.com.br

an
InBeta 
company